

# 9

## Applications of Integration

### 9.1 AREA BETWEEN CURVES

We have seen how integration can be used to find an area between a curve and the  $x$ -axis. With very little change we can find some areas between curves; indeed, the area between a curve and the  $x$ -axis may be interpreted as the area between the curve and a second “curve” with equation  $y = 0$ . In the simplest of cases, the idea is quite easy to understand.

**EXAMPLE 9.1.1** Find the area below  $f(x) = -x^2 + 4x + 3$  and above  $g(x) = -x^3 + 7x^2 - 10x + 5$  over the interval  $1 \leq x \leq 2$ . In figure 9.1.1 we show the two curves together, with the desired area shaded, then  $f$  alone with the area under  $f$  shaded, and then  $g$  alone with the area under  $g$  shaded.

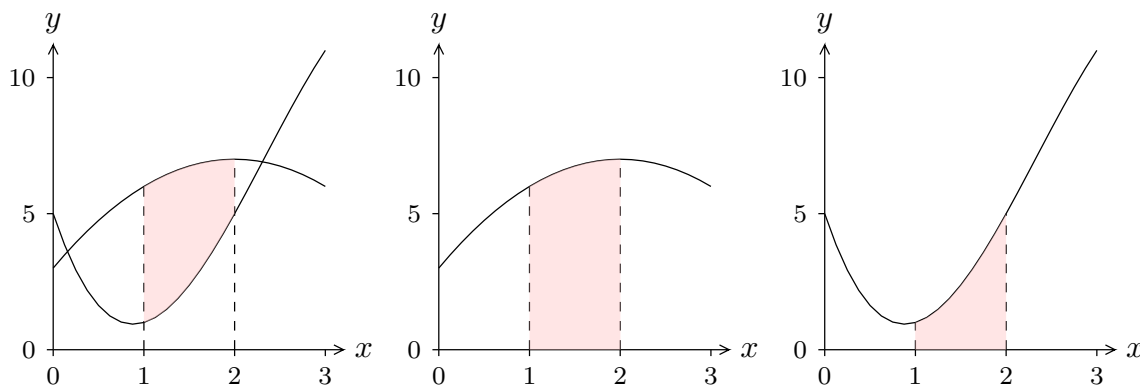

**Figure 9.1.1** Area between curves as a difference of areas.

## 192 Chapter 9 Applications of Integration

It is clear from the figure that the area we want is the area under  $f$  minus the area under  $g$ , which is to say

$$\int_1^2 f(x) dx - \int_1^2 g(x) dx = \int_1^2 f(x) - g(x) dx.$$

It doesn't matter whether we compute the two integrals on the left and then subtract or compute the single integral on the right. In this case, the latter is perhaps a bit easier:

$$\begin{aligned} \int_1^2 f(x) - g(x) dx &= \int_1^2 -x^2 + 4x + 3 - (-x^3 + 7x^2 - 10x + 5) dx \\ &= \int_1^2 x^3 - 8x^2 + 14x - 2 dx \\ &= \left. \frac{x^4}{4} - \frac{8x^3}{3} + 7x^2 - 2x \right|_1^2 \\ &= \frac{16}{4} - \frac{64}{3} + 28 - 4 - \left( \frac{1}{4} - \frac{8}{3} + 7 - 2 \right) \\ &= 23 - \frac{56}{3} - \frac{1}{4} = \frac{49}{12}. \end{aligned}$$

□

It is worth examining this problem a bit more. We have seen one way to look at it, by viewing the desired area as a big area minus a small area, which leads naturally to the difference between two integrals. But it is instructive to consider how we might find the desired area directly. We can approximate the area by dividing the area into thin sections and approximating the area of each section by a rectangle, as indicated in figure 9.1.2. The area of a typical rectangle is  $\Delta x(f(x_i) - g(x_i))$ , so the total area is approximately

$$\sum_{i=0}^{n-1} (f(x_i) - g(x_i)) \Delta x.$$

This is exactly the sort of sum that turns into an integral in the limit, namely the integral

$$\int_1^2 f(x) - g(x) dx.$$

Of course, this is the integral we actually computed above, but we have now arrived at it directly rather than as a modification of the difference between two other integrals. In that example it really doesn't matter which approach we take, but in some cases this second approach is better.

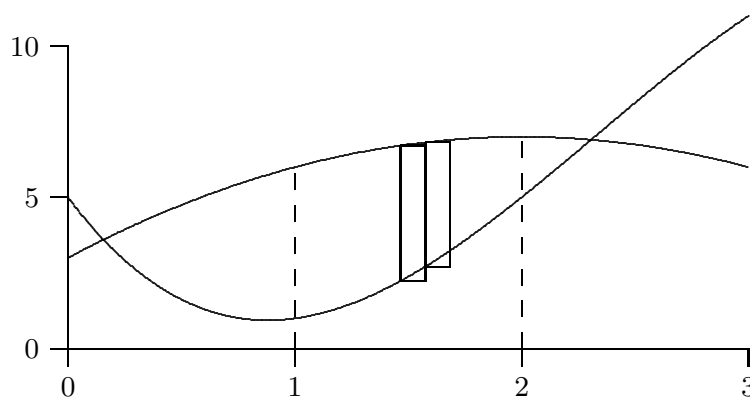
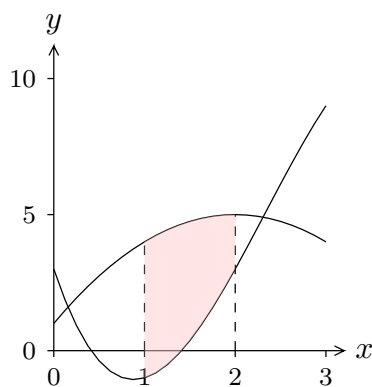

**Figure 9.1.2** Approximating area between curves with rectangles.

**EXAMPLE 9.1.2** Find the area below  $f(x) = -x^2 + 4x + 1$  and above  $g(x) = -x^3 + 7x^2 - 10x + 3$  over the interval  $1 \leq x \leq 2$ ; these are the same curves as before but lowered by 2. In figure 9.1.3 we show the two curves together. Note that the lower curve now dips below the  $x$ -axis. This makes it somewhat tricky to view the desired area as a big area minus a smaller area, but it is just as easy as before to think of approximating the area by rectangles. The height of a typical rectangle will still be  $f(x_i) - g(x_i)$ , even if  $g(x_i)$  is negative. Thus the area is

$$\int_1^2 -x^2 + 4x + 1 - (-x^3 + 7x^2 - 10x + 3) dx = \int_1^2 x^3 - 8x^2 + 14x - 2 dx.$$

This is of course the same integral as before, because the region between the curves is identical to the former region—it has just been moved down by 2.  $\square$



**Figure 9.1.3** Area between curves.

**EXAMPLE 9.1.3** Find the area between  $f(x) = -x^2 + 4x$  and  $g(x) = x^2 - 6x + 5$  over the interval  $0 \leq x \leq 1$ ; the curves are shown in figure 9.1.4. Generally we should interpret

“area” in the usual sense, as a necessarily positive quantity. Since the two curves cross, we need to compute two areas and add them. First we find the intersection point of the curves:

$$\begin{aligned} -x^2 + 4x &= x^2 - 6x + 5 \\ 0 &= 2x^2 - 10x + 5 \\ x &= \frac{10 \pm \sqrt{100 - 40}}{4} = \frac{5 \pm \sqrt{15}}{2}. \end{aligned}$$

The intersection point we want is  $x = a = (5 - \sqrt{15})/2$ . Then the total area is

$$\begin{aligned} \int_0^a x^2 - 6x + 5 - (-x^2 + 4x) dx + \int_a^1 -x^2 + 4x - (x^2 - 6x + 5) dx \\ &= \int_0^a 2x^2 - 10x + 5 dx + \int_a^1 -2x^2 + 10x - 5 dx \\ &= \left. \frac{2x^3}{3} - 5x^2 + 5x \right|_0^a + \left. -\frac{2x^3}{3} + 5x^2 - 5x \right|_a^1 \\ &= -\frac{52}{3} + 5\sqrt{15}, \end{aligned}$$

after a bit of simplification. □

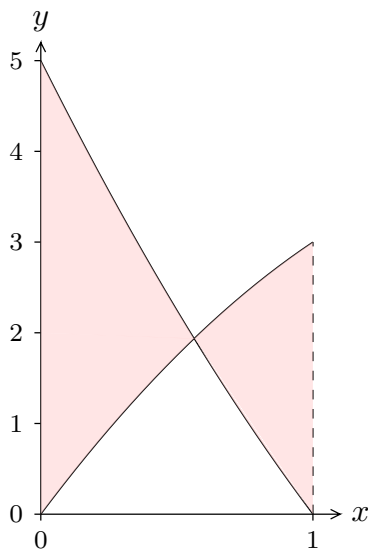

**Figure 9.1.4** Area between curves that cross.

**EXAMPLE 9.1.4** Find the area between  $f(x) = -x^2 + 4x$  and  $g(x) = x^2 - 6x + 5$ ; the curves are shown in figure 9.1.5. Here we are not given a specific interval, so it must

be the case that there is a “natural” region involved. Since the curves are both parabolas, the only reasonable interpretation is the region between the two intersection points, which we found in the previous example:

$$\frac{5 \pm \sqrt{15}}{2}.$$

If we let  $a = (5 - \sqrt{15})/2$  and  $b = (5 + \sqrt{15})/2$ , the total area is

$$\begin{aligned} \int_a^b -x^2 + 4x - (x^2 - 6x + 5) dx &= \int_a^b -2x^2 + 10x - 5 dx \\ &= -\frac{2x^3}{3} + 5x^2 - 5x \Big|_a^b \\ &= 5\sqrt{15}. \end{aligned}$$

after a bit of simplification. □

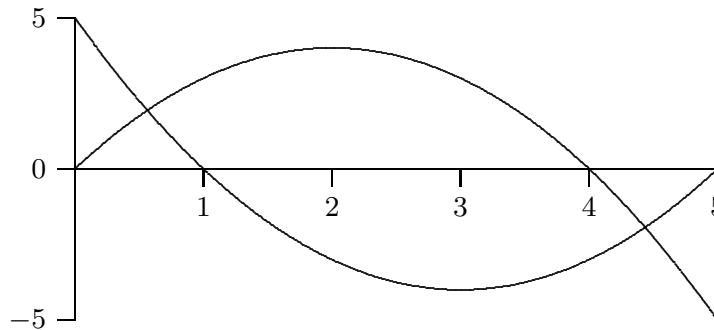

**Figure 9.1.5** Area bounded by two curves.

### ***Exercises 9.1.***

Find the area bounded by the curves.

1.  $y = x^4 - x^2$  and  $y = x^2$  (the part to the right of the  $y$ -axis)  $\Rightarrow$
2.  $x = y^3$  and  $x = y^2$   $\Rightarrow$
3.  $x = 1 - y^2$  and  $y = -x - 1$   $\Rightarrow$
4.  $x = 3y - y^2$  and  $x + y = 3$   $\Rightarrow$
5.  $y = \cos(\pi x/2)$  and  $y = 1 - x^2$  (in the first quadrant)  $\Rightarrow$
6.  $y = \sin(\pi x/3)$  and  $y = x$  (in the first quadrant)  $\Rightarrow$
7.  $y = \sqrt{x}$  and  $y = x^2$   $\Rightarrow$
8.  $y = \sqrt{x}$  and  $y = \sqrt{x+1}$ ,  $0 \leq x \leq 4$   $\Rightarrow$
9.  $x = 0$  and  $x = 25 - y^2$   $\Rightarrow$
10.  $y = \sin x \cos x$  and  $y = \sin x$ ,  $0 \leq x \leq \pi$   $\Rightarrow$

11.  $y = x^{3/2}$  and  $y = x^{2/3} \Rightarrow$   
 12.  $y = x^2 - 2x$  and  $y = x - 2 \Rightarrow$

The following three exercises expand on the geometric interpretation of the hyperbolic functions. Refer to section 4.11 and particularly to figure 4.11.2 and exercise 6 in section 4.11.

13. Compute  $\int \sqrt{x^2 - 1} dx$  using the substitution  $u = \operatorname{arccosh} x$ , or  $x = \cosh u$ ; use exercise 6 in section 4.11.  
 14. Fix  $t > 0$ . Sketch the region  $R$  in the right half plane bounded by the curves  $y = x \tanh t$ ,  $y = -x \tanh t$ , and  $x^2 - y^2 = 1$ . Note well:  $t$  is fixed, the plane is the  $x$ - $y$  plane.  
 15. Prove that the area of  $R$  is  $t$ .

## 9.2 DISTANCE, VELOCITY, ACCELERATION

We next recall a general principle that will later be applied to distance-velocity-acceleration problems, among other things. If  $F(u)$  is an anti-derivative of  $f(u)$ , then  $\int_a^b f(u) du = F(b) - F(a)$ . Suppose that we want to let the upper limit of integration vary, i.e., we replace  $b$  by some variable  $x$ . We think of  $a$  as a fixed starting value  $x_0$ . In this new notation the last equation (after adding  $F(a)$  to both sides) becomes:

$$F(x) = F(x_0) + \int_{x_0}^x f(u) du.$$

(Here  $u$  is the variable of integration, called a “dummy variable,” since it is not the variable in the function  $F(x)$ . In general, it is not a good idea to use the same letter as a variable of integration and as a limit of integration. That is,  $\int_{x_0}^x f(x) dx$  is bad notation, and can lead to errors and confusion.)

An important application of this principle occurs when we are interested in the position of an object at time  $t$  (say, on the  $x$ -axis) and we know its position at time  $t_0$ . Let  $s(t)$  denote the position of the object at time  $t$  (its distance from a reference point, such as the origin on the  $x$ -axis). Then the net change in position between  $t_0$  and  $t$  is  $s(t) - s(t_0)$ . Since  $s(t)$  is an anti-derivative of the velocity function  $v(t)$ , we can write

$$s(t) = s(t_0) + \int_{t_0}^t v(u) du.$$

Similarly, since the velocity is an anti-derivative of the acceleration function  $a(t)$ , we have

$$v(t) = v(t_0) + \int_{t_0}^t a(u) du.$$

**EXAMPLE 9.2.1** Suppose an object is acted upon by a constant force  $F$ . Find  $v(t)$  and  $s(t)$ . By Newton's law  $F = ma$ , so the acceleration is  $F/m$ , where  $m$  is the mass of the object. Then we first have

$$v(t) = v(t_0) + \int_{t_0}^t \frac{F}{m} du = v_0 + \frac{F}{m} u \Big|_{t_0}^t = v_0 + \frac{F}{m}(t - t_0),$$

using the usual convention  $v_0 = v(t_0)$ . Then

$$\begin{aligned} s(t) &= s(t_0) + \int_{t_0}^t \left( v_0 + \frac{F}{m}(u - t_0) \right) du = s_0 + (v_0 u + \frac{F}{2m}(u - t_0)^2) \Big|_{t_0}^t \\ &= s_0 + v_0(t - t_0) + \frac{F}{2m}(t - t_0)^2. \end{aligned}$$

For instance, when  $F/m = -g$  is the constant of gravitational acceleration, then this is the falling body formula (if we neglect air resistance) familiar from elementary physics:

$$s_0 + v_0(t - t_0) - \frac{g}{2}(t - t_0)^2,$$

or in the common case that  $t_0 = 0$ ,

$$s_0 + v_0 t - \frac{g}{2} t^2.$$

□

Recall that the integral of the velocity function gives the *net* distance traveled. If you want to know the *total* distance traveled, you must find out where the velocity function crosses the  $t$ -axis, integrate separately over the time intervals when  $v(t)$  is positive and when  $v(t)$  is negative, and add up the absolute values of the different integrals. For example, if an object is thrown straight upward at 19.6 m/sec, its velocity function is  $v(t) = -9.8t + 19.6$ , using  $g = 9.8$  m/sec for the force of gravity. This is a straight line which is positive for  $t < 2$  and negative for  $t > 2$ . The net distance traveled in the first 4 seconds is thus

$$\int_0^4 (-9.8t + 19.6) dt = 0,$$

while the total distance traveled in the first 4 seconds is

$$\int_0^2 (-9.8t + 19.6) dt + \left| \int_2^4 (-9.8t + 19.6) dt \right| = 19.6 + | -19.6 | = 39.2$$

meters, 19.6 meters up and 19.6 meters down.

**EXAMPLE 9.2.2** The acceleration of an object is given by  $a(t) = \cos(\pi t)$ , and its velocity at time  $t = 0$  is  $1/(2\pi)$ . Find both the net and the total distance traveled in the first 1.5 seconds.

We compute

$$v(t) = v(0) + \int_0^t \cos(\pi u) du = \frac{1}{2\pi} + \frac{1}{\pi} \sin(\pi u) \Big|_0^t = \frac{1}{\pi} \left( \frac{1}{2} + \sin(\pi t) \right).$$

The *net* distance traveled is then

$$\begin{aligned} s(3/2) - s(0) &= \int_0^{3/2} \frac{1}{\pi} \left( \frac{1}{2} + \sin(\pi t) \right) dt \\ &= \frac{1}{\pi} \left( \frac{t}{2} - \frac{1}{\pi} \cos(\pi t) \right) \Big|_0^{3/2} = \frac{3}{4\pi} + \frac{1}{\pi^2} \approx 0.340 \text{ meters.} \end{aligned}$$

To find the *total* distance traveled, we need to know when  $(0.5 + \sin(\pi t))$  is positive and when it is negative. This function is 0 when  $\sin(\pi t)$  is  $-0.5$ , i.e., when  $\pi t = 7\pi/6, 11\pi/6$ , etc. The value  $\pi t = 7\pi/6$ , i.e.,  $t = 7/6$ , is the only value in the range  $0 \leq t \leq 1.5$ . Since  $v(t) > 0$  for  $t < 7/6$  and  $v(t) < 0$  for  $t > 7/6$ , the total distance traveled is

$$\begin{aligned} & \int_0^{7/6} \frac{1}{\pi} \left( \frac{1}{2} + \sin(\pi t) \right) dt + \left| \int_{7/6}^{3/2} \frac{1}{\pi} \left( \frac{1}{2} + \sin(\pi t) \right) dt \right| \\ &= \frac{1}{\pi} \left( \frac{7}{12} + \frac{1}{\pi} \cos(7\pi/6) + \frac{1}{\pi} \right) + \frac{1}{\pi} \left| \frac{3}{4} - \frac{7}{12} + \frac{1}{\pi} \cos(7\pi/6) \right| \\ &= \frac{1}{\pi} \left( \frac{7}{12} + \frac{1}{\pi} \frac{\sqrt{3}}{2} + \frac{1}{\pi} \right) + \frac{1}{\pi} \left| \frac{3}{4} - \frac{7}{12} + \frac{1}{\pi} \frac{\sqrt{3}}{2} \right| \approx 0.409 \text{ meters.} \end{aligned}$$

□

### Exercises 9.2.

For each velocity function find both the net distance and the total distance traveled during the indicated time interval (graph  $v(t)$  to determine when it's positive and when it's negative):

1.  $v = \cos(\pi t)$ ,  $0 \leq t \leq 2.5 \Rightarrow$
2.  $v = -9.8t + 49$ ,  $0 \leq t \leq 10 \Rightarrow$
3.  $v = 3(t - 3)(t - 1)$ ,  $0 \leq t \leq 5 \Rightarrow$
4.  $v = \sin(\pi t/3) - t$ ,  $0 \leq t \leq 1 \Rightarrow$
5. An object is shot upwards from ground level with an initial velocity of 2 meters per second; it is subject only to the force of gravity (no air resistance). Find its maximum altitude and the time at which it hits the ground.  $\Rightarrow$
6. An object is shot upwards from ground level with an initial velocity of 3 meters per second; it is subject only to the force of gravity (no air resistance). Find its maximum altitude and the time at which it hits the ground.  $\Rightarrow$



7. An object is shot upwards from ground level with an initial velocity of 100 meters per second; it is subject only to the force of gravity (no air resistance). Find its maximum altitude and the time at which it hits the ground.  $\Rightarrow$
8. An object moves along a straight line with acceleration given by  $a(t) = -\cos(t)$ , and  $s(0) = 1$  and  $v(0) = 0$ . Find the maximum distance the object travels from zero, and find its maximum speed. Describe the motion of the object.  $\Rightarrow$
9. An object moves along a straight line with acceleration given by  $a(t) = \sin(\pi t)$ . Assume that when  $t = 0$ ,  $s(t) = v(t) = 0$ . Find  $s(t)$ ,  $v(t)$ , and the maximum speed of the object. Describe the motion of the object.  $\Rightarrow$
10. An object moves along a straight line with acceleration given by  $a(t) = 1 + \sin(\pi t)$ . Assume that when  $t = 0$ ,  $s(t) = v(t) = 0$ . Find  $s(t)$  and  $v(t)$ .  $\Rightarrow$
11. An object moves along a straight line with acceleration given by  $a(t) = 1 - \sin(\pi t)$ . Assume that when  $t = 0$ ,  $s(t) = v(t) = 0$ . Find  $s(t)$  and  $v(t)$ .  $\Rightarrow$

### 9.3 VOLUME

We have seen how to compute certain areas by using integration; some volumes may also be computed by evaluating an integral. Generally, the volumes that we can compute this way have cross-sections that are easy to describe.

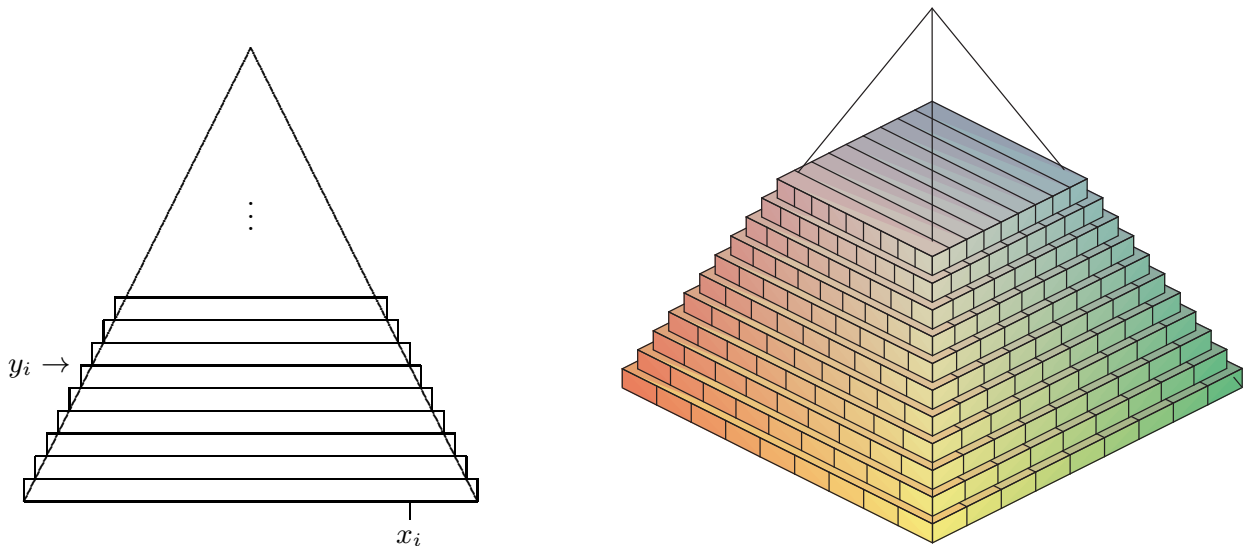

**Figure 9.3.1** Volume of a pyramid approximated by rectangular prisms. (AP)

**EXAMPLE 9.3.1** Find the volume of a pyramid with a square base that is 20 meters tall and 20 meters on a side at the base. As with most of our applications of integration, we begin by asking how we might approximate the volume. Since we can easily compute the volume of a rectangular prism (that is, a “box”), we will use some boxes to approximate

the volume of the pyramid, as shown in figure 9.3.1: on the left is a cross-sectional view, on the right is a 3D view of part of the pyramid with some of the boxes used to approximate the volume.

Each box has volume of the form  $(2x_i)(2x_i)\Delta y$ . Unfortunately, there are two variables here; fortunately, we can write  $x$  in terms of  $y$ :  $x = 10 - y/2$  or  $x_i = 10 - y_i/2$ . Then the total volume is approximately

$$\sum_{i=0}^{n-1} 4(10 - y_i/2)^2 \Delta y$$

and in the limit we get the volume as the value of an integral:

$$\int_0^{20} 4(10 - y/2)^2 dy = \int_0^{20} (20 - y)^2 dy = -\frac{(20 - y)^3}{3} \Big|_0^{20} = -\frac{0^3}{3} - \left(-\frac{20^3}{3}\right) = \frac{8000}{3}.$$

As you may know, the volume of a pyramid is  $(1/3)(\text{height})(\text{area of base}) = (1/3)(20)(400)$ , which agrees with our answer.  $\square$

**EXAMPLE 9.3.2** The base of a solid is the region between  $f(x) = x^2 - 1$  and  $g(x) = -x^2 + 1$ , and its cross-sections perpendicular to the  $x$ -axis are equilateral triangles, as indicated in figure 9.3.2. The solid has been truncated to show a triangular cross-section above  $x = 1/2$ . Find the volume of the solid.

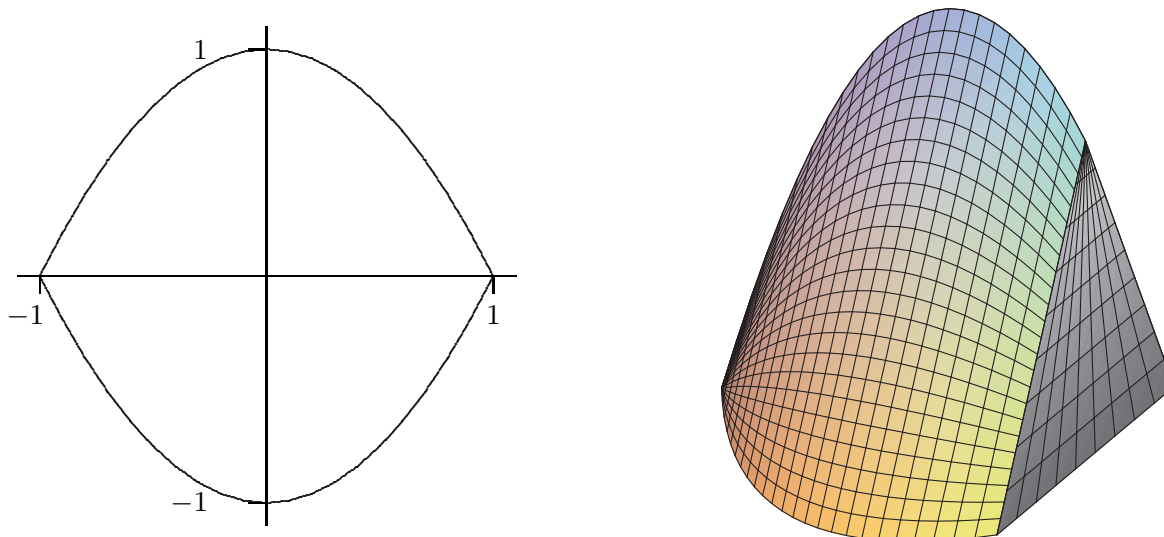

**Figure 9.3.2** Solid with equilateral triangles as cross-sections. (AP)

A cross-section at a value  $x_i$  on the  $x$ -axis is a triangle with base  $2(1 - x_i^2)$  and height  $\sqrt{3}(1 - x_i^2)$ , so the area of the cross-section is

$$\frac{1}{2}(\text{base})(\text{height}) = (1 - x_i^2)\sqrt{3}(1 - x_i^2),$$

and the volume of a thin “slab” is then

$$(1 - x_i^2)\sqrt{3}(1 - x_i^2)\Delta x.$$

Thus the total volume is

$$\int_{-1}^1 \sqrt{3}(1 - x^2)^2 dx = \frac{16}{15}\sqrt{3}.$$

□

One easy way to get “nice” cross-sections is by rotating a plane figure around a line. For example, in figure 9.3.3 we see a plane region under a curve and between two vertical lines; then the result of rotating this around the  $x$ -axis, and a typical circular cross-section.

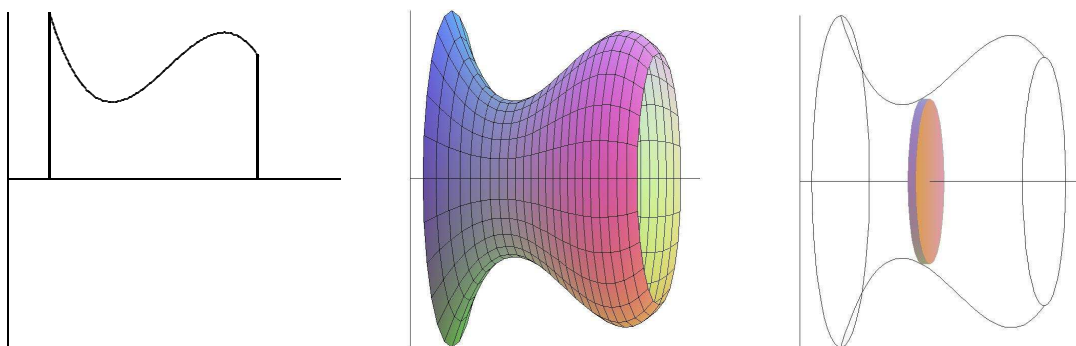

**Figure 9.3.3** A solid of rotation.

Of course a real “slice” of this figure will not have straight sides, but we can approximate the volume of the slice by a cylinder or disk with circular top and bottom and straight sides; the volume of this disk will have the form  $\pi r^2 \Delta x$ . As long as we can write  $r$  in terms of  $x$  we can compute the volume by an integral.

**EXAMPLE 9.3.3** Find the volume of a right circular cone with base radius 10 and height 20. (A right circular cone is one with a circular base and with the tip of the cone directly over the center of the base.) We can view this cone as produced by the rotation of the line  $y = x/2$  rotated about the  $x$ -axis, as indicated in figure 9.3.4.

At a particular point on the  $x$ -axis, say  $x_i$ , the radius of the resulting cone is the  $y$ -coordinate of the corresponding point on the line, namely  $y_i = x_i/2$ . Thus the total volume is approximately

$$\sum_{i=0}^{n-1} \pi(x_i/2)^2 dx$$

and the exact volume is

$$\int_0^{20} \pi \frac{x^2}{4} dx = \frac{\pi}{4} \frac{20^3}{3} = \frac{2000\pi}{3}.$$

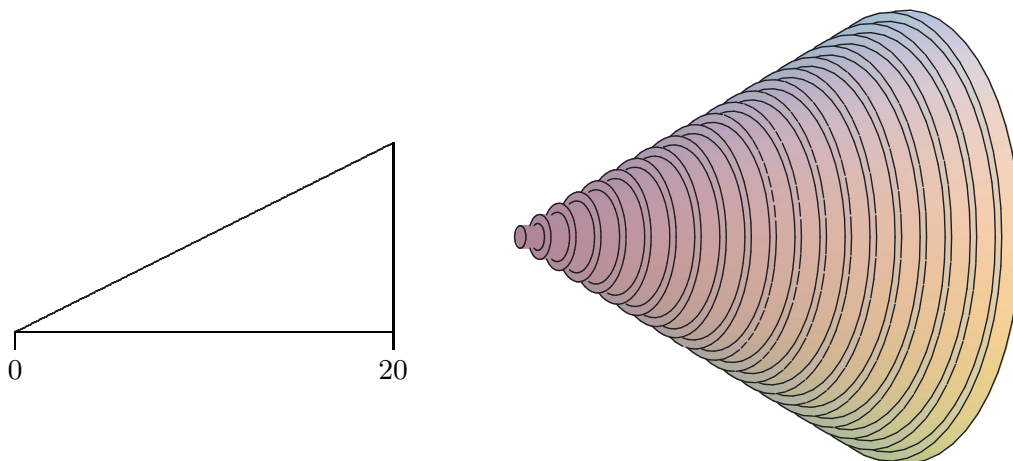

**Figure 9.3.4** Approximating the volume of a cone by circular disks.

Note that we can instead do the calculation with a generic height and radius:

$$\int_0^h \pi \frac{r^2}{h^2} x^2 dx = \frac{\pi r^2}{h^2} \frac{h^3}{3} = \frac{\pi r^2 h}{3},$$

giving us the usual formula for the volume of a cone. □

**EXAMPLE 9.3.4** Find the volume of the object generated when the area between  $y = x^2$  and  $y = x$  is rotated around the  $x$ -axis. This solid has a “hole” in the middle; we can compute the volume by subtracting the volume of the hole from the volume enclosed by the outer surface of the solid. In figure 9.3.5 we show the region that is rotated, the resulting solid with the front half cut away, the cone that forms the outer surface, the horn-shaped hole, and a cross-section perpendicular to the  $x$ -axis.

We have already computed the volume of a cone; in this case it is  $\pi/3$ . At a particular value of  $x$ , say  $x_i$ , the cross-section of the horn is a circle with radius  $x_i^2$ , so the volume of the horn is

$$\int_0^1 \pi (x^2)^2 dx = \int_0^1 \pi x^4 dx = \pi \frac{1}{5},$$

so the desired volume is  $\pi/3 - \pi/5 = 2\pi/15$ .

As with the area between curves, there is an alternate approach that computes the desired volume “all at once” by approximating the volume of the actual solid. We can approximate the volume of a slice of the solid with a washer-shaped volume, as indicated in figure 9.3.5.

The volume of such a washer is the area of the face times the thickness. The thickness, as usual, is  $\Delta x$ , while the area of the face is the area of the outer circle minus the area of

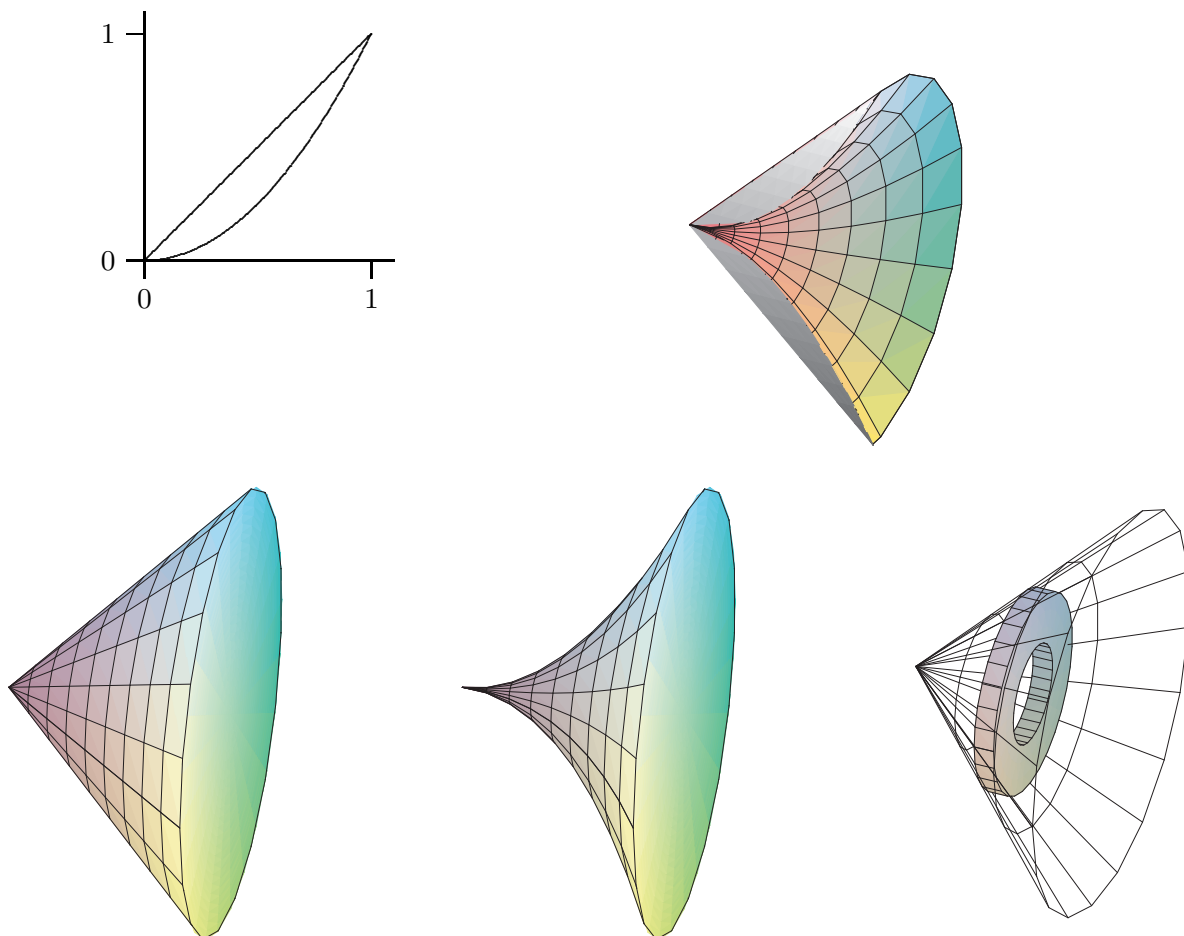

**Figure 9.3.5** Solid with a hole, showing the outer cone and the shape to be removed to form the hole. (AP)

the inner circle, say  $\pi R^2 - \pi r^2$ . In the present example, at a particular  $x_i$ , the radius  $R$  is  $x_i$  and  $r$  is  $x_i^2$ . Hence, the whole volume is

$$\int_0^1 \pi x^2 - \pi x^4 dx = \pi \left( \frac{x^3}{3} - \frac{x^5}{5} \right) \Big|_0^1 = \pi \left( \frac{1}{3} - \frac{1}{5} \right) = \frac{2\pi}{15}.$$

Of course, what we have done here is exactly the same calculation as before, except we have in effect recomputed the volume of the outer cone.  $\square$

Suppose the region between  $f(x) = x + 1$  and  $g(x) = (x - 1)^2$  is rotated around the  $y$ -axis; see figure 9.3.6. It is possible, but inconvenient, to compute the volume of the resulting solid by the method we have used so far. The problem is that there are two “kinds” of typical rectangles: those that go from the line to the parabola and those that touch the parabola on both ends. To compute the volume using this approach, we need to

break the problem into two parts and compute two integrals:

$$\pi \int_0^1 (1 + \sqrt{y})^2 - (1 - \sqrt{y})^2 dy + \pi \int_1^4 (1 + \sqrt{y})^2 - (y - 1)^2 dy = \frac{8}{3}\pi + \frac{65}{6}\pi = \frac{27}{2}\pi.$$

If instead we consider a typical vertical rectangle, but still rotate around the  $y$ -axis, we get a thin “shell” instead of a thin “washer”. If we add up the volume of such thin shells we will get an approximation to the true volume. What is the volume of such a shell? Consider the shell at  $x_i$ . Imagine that we cut the shell vertically in one place and “unroll” it into a thin, flat sheet. This sheet will be almost a rectangular prism that is  $\Delta x$  thick,  $f(x_i) - g(x_i)$  tall, and  $2\pi x_i$  wide (namely, the circumference of the shell before it was unrolled). The volume will then be approximately the volume of a rectangular prism with these dimensions:  $2\pi x_i(f(x_i) - g(x_i))\Delta x$ . If we add these up and take the limit as usual, we get the integral

$$\int_0^3 2\pi x(f(x) - g(x)) dx = \int_0^3 2\pi x(x + 1 - (x - 1)^2) dx = \frac{27}{2}\pi.$$

Not only does this accomplish the task with only one integral, the integral is somewhat easier than those in the previous calculation. Things are not always so neat, but it is often the case that one of the two methods will be simpler than the other, so it is worth considering both before starting to do calculations.

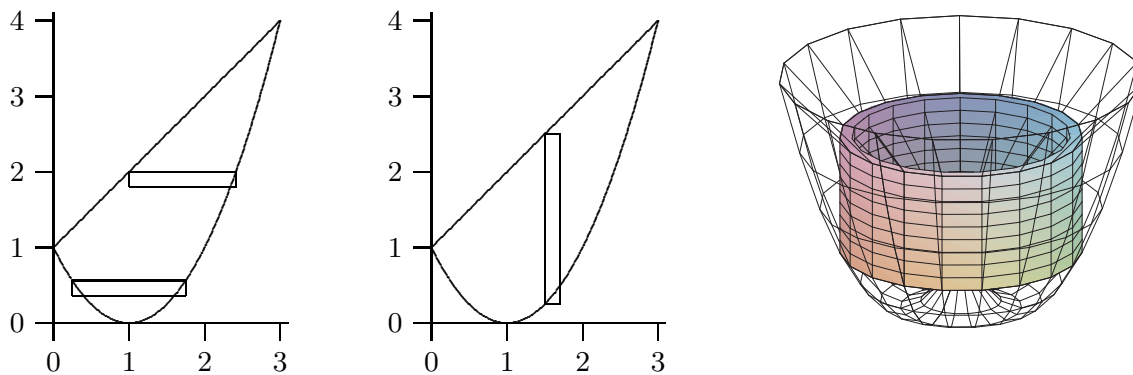

Figure 9.3.6 Computing volumes with “shells”. (AP)

**EXAMPLE 9.3.5** Suppose the area under  $y = -x^2 + 1$  between  $x = 0$  and  $x = 1$  is rotated around the  $x$ -axis. Find the volume by both methods.

Disk method:  $\int_0^1 \pi(1 - x^2)^2 dx = \frac{8}{15}\pi.$

Shell method:  $\int_0^1 2\pi y\sqrt{1 - y} dy = \frac{8}{15}\pi. \quad \square$

**Exercises 9.3.**

1. Verify that  $\pi \int_0^1 (1 + \sqrt{y})^2 - (1 - \sqrt{y})^2 dy + \pi \int_1^4 (1 + \sqrt{y})^2 - (y - 1)^2 = \frac{8}{3}\pi + \frac{65}{6}\pi = \frac{27}{2}\pi$ .
2. Verify that  $\int_0^3 2\pi x(x + 1 - (x - 1)^2) dx = \frac{27}{2}\pi$ .
3. Verify that  $\int_0^1 \pi(1 - x^2)^2 dx = \frac{8}{15}\pi$ .
4. Verify that  $\int_0^1 2\pi y\sqrt{1 - y} dy = \frac{8}{15}\pi$ .
5. Use integration to find the volume of the solid obtained by revolving the region bounded by  $x + y = 2$  and the  $x$  and  $y$  axes around the  $x$ -axis.  $\Rightarrow$
6. Find the volume of the solid obtained by revolving the region bounded by  $y = x - x^2$  and the  $x$ -axis around the  $x$ -axis.  $\Rightarrow$
7. Find the volume of the solid obtained by revolving the region bounded by  $y = \sqrt{\sin x}$  between  $x = 0$  and  $x = \pi/2$ , the  $y$ -axis, and the line  $y = 1$  around the  $x$ -axis.  $\Rightarrow$
8. Let  $S$  be the region of the  $xy$ -plane bounded above by the curve  $x^3y = 64$ , below by the line  $y = 1$ , on the left by the line  $x = 2$ , and on the right by the line  $x = 4$ . Find the volume of the solid obtained by rotating  $S$  around (a) the  $x$ -axis, (b) the line  $y = 1$ , (c) the  $y$ -axis, (d) the line  $x = 2$ .  $\Rightarrow$
9. The equation  $x^2/9 + y^2/4 = 1$  describes an ellipse. Find the volume of the solid obtained by rotating the ellipse around the  $x$ -axis and also around the  $y$ -axis. These solids are called **ellipsoids**; one is vaguely rugby-ball shaped, one is sort of flying-saucer shaped, or perhaps squished-beach-ball-shaped.  $\Rightarrow$

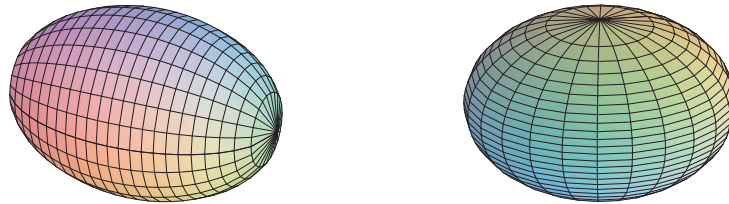
**Figure 9.3.7** Ellipsoids. (AP)

10. Use integration to compute the volume of a sphere of radius  $r$ . You should of course get the well-known formula  $4\pi r^3/3$ .
11. A hemispheric bowl of radius  $r$  contains water to a depth  $h$ . Find the volume of water in the bowl.  $\Rightarrow$
12. The base of a tetrahedron (a triangular pyramid) of height  $h$  is an equilateral triangle of side  $s$ . Its cross-sections perpendicular to an altitude are equilateral triangles. Express its volume  $V$  as an integral, and find a formula for  $V$  in terms of  $h$  and  $s$ . Verify that your answer is  $(1/3)(\text{area of base})(\text{height})$ .
13. The base of a solid is the region between  $f(x) = \cos x$  and  $g(x) = -\cos x$ ,  $-\pi/2 \leq x \leq \pi/2$ , and its cross-sections perpendicular to the  $x$ -axis are squares. Find the volume of the solid.  $\Rightarrow$

## 9.4 AVERAGE VALUE OF A FUNCTION

The average of some finite set of values is a familiar concept. If, for example, the class scores on a quiz are 10, 9, 10, 8, 7, 5, 7, 6, 3, 2, 7, 8, then the average score is the sum of these numbers divided by the size of the class:

$$\text{average score} = \frac{10 + 9 + 10 + 8 + 7 + 5 + 7 + 6 + 3 + 2 + 7 + 8}{12} = \frac{82}{12} \approx 6.83.$$

Suppose that between  $t = 0$  and  $t = 1$  the speed of an object is  $\sin(\pi t)$ . What is the average speed of the object over that time? The question sounds as if it must make sense, yet we can't merely add up some number of speeds and divide, since the speed is changing continuously over the time interval.

To make sense of "average" in this context, we fall back on the idea of approximation. Consider the speed of the object at tenth of a second intervals:  $\sin 0$ ,  $\sin(0.1\pi)$ ,  $\sin(0.2\pi)$ ,  $\sin(0.3\pi)$ ,  $\dots$ ,  $\sin(0.9\pi)$ . The average speed "should" be fairly close to the average of these ten speeds:

$$\frac{1}{10} \sum_{i=0}^9 \sin(\pi i/10) \approx \frac{1}{10} 6.3 = 0.63.$$

Of course, if we compute more speeds at more times, the average of these speeds should be closer to the "real" average. If we take the average of  $n$  speeds at evenly spaced times, we get:

$$\frac{1}{n} \sum_{i=0}^{n-1} \sin(\pi i/n).$$

Here the individual times are  $t_i = i/n$ , so rewriting slightly we have

$$\frac{1}{n} \sum_{i=0}^{n-1} \sin(\pi t_i).$$

This is almost the sort of sum that we know turns into an integral; what's apparently missing is  $\Delta t$ —but in fact,  $\Delta t = 1/n$ , the length of each subinterval. So rewriting again:

$$\sum_{i=0}^{n-1} \sin(\pi t_i) \frac{1}{n} = \sum_{i=0}^{n-1} \sin(\pi t_i) \Delta t.$$

Now this has exactly the right form, so that in the limit we get

$$\text{average speed} = \int_0^1 \sin(\pi t) dt = -\frac{\cos(\pi t)}{\pi} \Big|_0^1 = -\frac{\cos(\pi)}{\pi} + \frac{\cos(0)}{\pi} = \frac{2}{\pi} \approx 0.6366 \approx 0.64.$$

It's not entirely obvious from this one simple example how to compute such an average in general. Let's look at a somewhat more complicated case. Suppose that the velocity



of an object is  $16t^2 + 5$  feet per second. What is the average velocity between  $t = 1$  and  $t = 3$ ? Again we set up an approximation to the average:

$$\frac{1}{n} \sum_{i=0}^{n-1} 16t_i^2 + 5,$$

where the values  $t_i$  are evenly spaced times between 1 and 3. Once again we are “missing”  $\Delta t$ , and this time  $1/n$  is not the correct value. What is  $\Delta t$  in general? It is the length of a subinterval; in this case we take the interval  $[1, 3]$  and divide it into  $n$  subintervals, so each has length  $(3 - 1)/n = 2/n = \Delta t$ . Now with the usual “multiply and divide by the same thing” trick we can rewrite the sum:

$$\frac{1}{n} \sum_{i=0}^{n-1} 16t_i^2 + 5 = \frac{1}{3-1} \sum_{i=0}^{n-1} (16t_i^2 + 5) \frac{3-1}{n} = \frac{1}{2} \sum_{i=0}^{n-1} (16t_i^2 + 5) \frac{2}{n} = \frac{1}{2} \sum_{i=0}^{n-1} (16t_i^2 + 5) \Delta t.$$

In the limit this becomes

$$\frac{1}{2} \int_1^3 16t^2 + 5 dt = \frac{1}{2} \frac{446}{3} = \frac{223}{3}.$$

Does this seem reasonable? Let’s picture it: in figure 9.4.1 is the velocity function together with the horizontal line  $y = 223/3 \approx 74.3$ . Certainly the height of the horizontal line looks at least plausible for the average height of the curve.

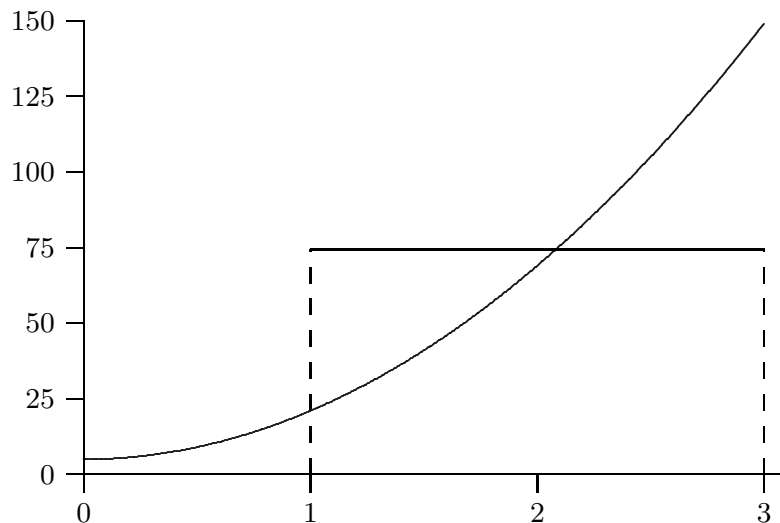

**Figure 9.4.1** Average velocity.

Here’s another way to interpret “average” that may make our computation appear even more reasonable. The object of our example goes a certain distance between  $t = 1$

and  $t = 3$ . If instead the object were to travel at the average speed over the same time, it should go the same distance. At an average speed of  $223/3$  feet per second for two seconds the object would go  $446/3$  feet. How far does it actually go? We know how to compute this:

$$\int_1^3 v(t) dt = \int_1^3 16t^2 + 5 dt = \frac{446}{3}.$$

So now we see that another interpretation of the calculation

$$\frac{1}{2} \int_1^3 16t^2 + 5 dt = \frac{1}{2} \frac{446}{3} = \frac{223}{3}$$

is: total distance traveled divided by the time in transit, namely, the usual interpretation of average speed.

In the case of speed, or more properly velocity, we can always interpret “average” as total (net) distance divided by time. But in the case of a different sort of quantity this interpretation does not obviously apply, while the approximation approach always does. We might interpret the same problem geometrically: what is the average height of  $16x^2 + 5$  on the interval  $[1, 3]$ ? We approximate this in exactly the same way, by adding up many sample heights and dividing by the number of samples. In the limit we get the same result:

$$\lim_{n \rightarrow \infty} \frac{1}{n} \sum_{i=0}^{n-1} 16x_i^2 + 5 = \frac{1}{2} \int_1^3 16x^2 + 5 dx = \frac{1}{2} \frac{446}{3} = \frac{223}{3}.$$

We can interpret this result in a slightly different way. The area under  $y = 16x^2 + 5$  above  $[1, 3]$  is

$$\int_1^3 16t^2 + 5 dt = \frac{446}{3}.$$

The area under  $y = 223/3$  over the same interval  $[1, 3]$  is simply the area of a rectangle that is 2 by  $223/3$  with area  $446/3$ . So the average height of a function is the height of the horizontal line that produces the same area over the given interval.

### ***Exercises 9.4.***

1. Find the average height of  $\cos x$  over the intervals  $[0, \pi/2]$ ,  $[-\pi/2, \pi/2]$ , and  $[0, 2\pi]$ .  $\Rightarrow$
2. Find the average height of  $x^2$  over the interval  $[-2, 2]$ .  $\Rightarrow$
3. Find the average height of  $1/x^2$  over the interval  $[1, A]$ .  $\Rightarrow$
4. Find the average height of  $\sqrt{1-x^2}$  over the interval  $[-1, 1]$ .  $\Rightarrow$
5. An object moves with velocity  $v(t) = -t^2 + 1$  feet per second between  $t = 0$  and  $t = 2$ . Find the average velocity and the average speed of the object between  $t = 0$  and  $t = 2$ .  $\Rightarrow$

6. The observation deck on the 102nd floor of the Empire State Building is 1,224 feet above the ground. If a steel ball is dropped from the observation deck its velocity at time  $t$  is approximately  $v(t) = -32t$  feet per second. Find the average speed between the time it is dropped and the time it hits the ground, and find its speed when it hits the ground.  $\Rightarrow$

## 9.5 WORK

A fundamental concept in classical physics is **work**: If an object is moved in a straight line against a force  $F$  for a distance  $s$  the work done is  $W = Fs$ .

**EXAMPLE 9.5.1** How much work is done in lifting a 10 pound weight vertically a distance of 5 feet? The force due to gravity on a 10 pound weight is 10 pounds at the surface of the earth, and it does not change appreciably over 5 feet. The work done is  $W = 10 \cdot 5 = 50$  foot-pounds.  $\square$

In reality few situations are so simple. The force might not be constant over the range of motion, as in the next example.

**EXAMPLE 9.5.2** How much work is done in lifting a 10 pound weight from the surface of the earth to an orbit 100 miles above the surface? Over 100 miles the force due to gravity does change significantly, so we need to take this into account. The force exerted on a 10 pound weight at a distance  $r$  from the center of the earth is  $F = k/r^2$  and by definition it is 10 when  $r$  is the radius of the earth (we assume the earth is a sphere). How can we approximate the work done? We divide the path from the surface to orbit into  $n$  small subpaths. On each subpath the force due to gravity is roughly constant, with value  $k/r_i^2$  at distance  $r_i$ . The work to raise the object from  $r_i$  to  $r_{i+1}$  is thus approximately  $k/r_i^2 \Delta r$  and the total work is approximately

$$\sum_{i=0}^{n-1} \frac{k}{r_i^2} \Delta r,$$

or in the limit

$$W = \int_{r_0}^{r_1} \frac{k}{r^2} dr,$$

where  $r_0$  is the radius of the earth and  $r_1$  is  $r_0$  plus 100 miles. The work is

$$W = \int_{r_0}^{r_1} \frac{k}{r^2} dr = -\left. \frac{k}{r} \right|_{r_0}^{r_1} = -\frac{k}{r_1} + \frac{k}{r_0}.$$

Using  $r_0 = 20925525$  feet we have  $r_1 = 21453525$ . The force on the 10 pound weight at the surface of the earth is 10 pounds, so  $10 = k/20925525^2$ , giving  $k = 4378775965256250$ .

Then

$$-\frac{k}{r_1} + \frac{k}{r_0} = \frac{491052320000}{95349} \approx 5150052 \text{ foot-pounds.}$$

Note that if we assume the force due to gravity is 10 pounds over the whole distance we would calculate the work as  $10(r_1 - r_0) = 10 \cdot 100 \cdot 5280 = 5280000$ , somewhat higher since we don't account for the weakening of the gravitational force.  $\square$

**EXAMPLE 9.5.3** How much work is done in lifting a 10 kilogram object from the surface of the earth to a distance  $D$  from the center of the earth? This is the same problem as before in different units, and we are not specifying a value for  $D$ . As before

$$W = \int_{r_0}^D \frac{k}{r^2} dr = -\left. \frac{k}{r} \right|_{r_0}^D = -\frac{k}{D} + \frac{k}{r_0}.$$

While “weight in pounds” is a measure of force, “weight in kilograms” is a measure of mass. To convert to force we need to use Newton's law  $F = ma$ . At the surface of the earth the acceleration due to gravity is approximately 9.8 meters per second squared, so the force is  $F = 10 \cdot 9.8 = 98$ . The units here are “kilogram-meters per second squared” or “kg m/s<sup>2</sup>”, also known as a Newton (N), so  $F = 98$  N. The radius of the earth is approximately 6378.1 kilometers or 6378100 meters. Now the problem proceeds as before. From  $F = k/r^2$  we compute  $k$ :  $98 = k/6378100^2$ ,  $k = 3.986655642 \cdot 10^{15}$ . Then the work is:

$$W = -\frac{k}{D} + 6.250538000 \cdot 10^8 \text{ Newton-meters.}$$

As  $D$  increases  $W$  of course gets larger, since the quantity being subtracted,  $-k/D$ , gets smaller. But note that the work  $W$  will never exceed  $6.250538000 \cdot 10^8$ , and in fact will approach this value as  $D$  gets larger. In short, with a finite amount of work, namely  $6.250538000 \cdot 10^8$  N-m, we can lift the 10 kilogram object as far as we wish from earth.  $\square$

Next is an example in which the force is constant, but there are many objects moving different distances.

**EXAMPLE 9.5.4** Suppose that a water tank is shaped like a right circular cone with the tip at the bottom, and has height 10 meters and radius 2 meters at the top. If the tank is full, how much work is required to pump all the water out over the top? Here we have a large number of atoms of water that must be lifted different distances to get to the top of the tank. Fortunately, we don't really have to deal with individual atoms—we can consider all the atoms at a given depth together.

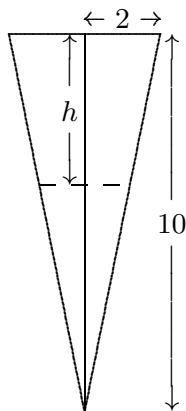

**Figure 9.5.1** Cross-section of a conical water tank.

To approximate the work, we can divide the water in the tank into horizontal sections, approximate the volume of water in a section by a thin disk, and compute the amount of work required to lift each disk to the top of the tank. As usual, we take the limit as the sections get thinner and thinner to get the total work.

At depth  $h$  the circular cross-section through the tank has radius  $r = (10 - h)/5$ , by similar triangles, and area  $\pi(10 - h)^2/25$ . A section of the tank at depth  $h$  thus has volume approximately  $\pi(10 - h)^2/25\Delta h$  and so contains  $\sigma\pi(10 - h)^2/25\Delta h$  kilograms of water, where  $\sigma$  is the density of water in kilograms per cubic meter;  $\sigma \approx 1000$ . The force due to gravity on this much water is  $9.8\sigma\pi(10 - h)^2/25\Delta h$ , and finally, this section of water must be lifted a distance  $h$ , which requires  $h9.8\sigma\pi(10 - h)^2/25\Delta h$  Newton-meters of work. The total work is therefore

$$W = \frac{9.8\sigma\pi}{25} \int_0^{10} h(10 - h)^2 dh = \frac{980000}{3}\pi \approx 1026254 \text{ Newton-meters.}$$

□

A spring has a “natural length,” its length if nothing is stretching or compressing it. If the spring is either stretched or compressed the spring provides an opposing force; according to **Hooke’s Law** the magnitude of this force is proportional to the distance the spring has been stretched or compressed:  $F = kx$ . The constant of proportionality,  $k$ , of course depends on the spring. Note that  $x$  here represents the *change* in length from the natural length.

**EXAMPLE 9.5.5** Suppose  $k = 5$  for a given spring that has a natural length of 0.1 meters. Suppose a force is applied that compresses the spring to length 0.08. What is the magnitude of the force? Assuming that the constant  $k$  has appropriate dimensions (namely,  $\text{kg/s}^2$ ), the force is  $5(0.1 - 0.08) = 5(0.02) = 0.1$  Newtons. □

**EXAMPLE 9.5.6** How much work is done in compressing the spring in the previous example from its natural length to 0.08 meters? From 0.08 meters to 0.05 meters? How much work is done to stretch the spring from 0.1 meters to 0.15 meters? We can approximate the work by dividing the distance that the spring is compressed (or stretched) into small subintervals. Then the force exerted by the spring is approximately constant over the subinterval, so the work required to compress the spring from  $x_i$  to  $x_{i+1}$  is approximately  $5(x_i - 0.1)\Delta x$ . The total work is approximately

$$\sum_{i=0}^{n-1} 5(x_i - 0.1)\Delta x$$

and in the limit

$$W = \int_{0.1}^{0.08} 5(x - 0.1) dx = \left. \frac{5(x - 0.1)^2}{2} \right|_{0.1}^{0.08} = \frac{5(0.08 - 0.1)^2}{2} - \frac{5(0.1 - 0.1)^2}{2} = \frac{1}{1000} \text{ N}\cdot\text{m}.$$

The other values we seek simply use different limits. To compress the spring from 0.08 meters to 0.05 meters takes

$$W = \int_{0.08}^{0.05} 5(x - 0.1) dx = \left. \frac{5x^2}{2} \right|_{0.08}^{0.05} = \frac{5(0.05 - 0.1)^2}{2} - \frac{5(0.08 - 0.1)^2}{2} = \frac{21}{4000} \text{ N}\cdot\text{m}$$

and to stretch the spring from 0.1 meters to 0.15 meters requires

$$W = \int_{0.1}^{0.15} 5(x - 0.1) dx = \left. \frac{5x^2}{2} \right|_{0.1}^{0.15} = \frac{5(0.15 - 0.1)^2}{2} - \frac{5(0.1 - 0.1)^2}{2} = \frac{1}{160} \text{ N}\cdot\text{m}.$$

□

### ***Exercises 9.5.***

1. How much work is done in lifting a 100 kilogram weight from the surface of the earth to an orbit 35,786 kilometers above the surface of the earth?  $\Rightarrow$
2. How much work is done in lifting a 100 kilogram weight from an orbit 1000 kilometers above the surface of the earth to an orbit 35,786 kilometers above the surface of the earth?  $\Rightarrow$
3. A water tank has the shape of an upright cylinder with radius  $r = 1$  meter and height 10 meters. If the depth of the water is 5 meters, how much work is required to pump all the water out the top of the tank?  $\Rightarrow$
4. Suppose the tank of the previous problem is lying on its side, so that the circular ends are vertical, and that it has the same amount of water as before. How much work is required to pump the water out the top of the tank (which is now 2 meters above the bottom of the tank)?  $\Rightarrow$

5. A water tank has the shape of the bottom half of a sphere with radius  $r = 1$  meter. If the tank is full, how much work is required to pump all the water out the top of the tank?  $\Rightarrow$
6. A spring has constant  $k = 10 \text{ kg/s}^2$ . How much work is done in compressing it  $1/10$  meter from its natural length?  $\Rightarrow$
7. A force of 2 Newtons will compress a spring from 1 meter (its natural length) to 0.8 meters. How much work is required to stretch the spring from 1.1 meters to 1.5 meters?  $\Rightarrow$
8. A 20 meter long steel cable has density 2 kilograms per meter, and is hanging straight down. How much work is required to lift the entire cable to the height of its top end?  $\Rightarrow$
9. The cable in the previous problem has a 100 kilogram bucket of concrete attached to its lower end. How much work is required to lift the entire cable and bucket to the height of its top end?  $\Rightarrow$
10. Consider again the cable and bucket of the previous problem. How much work is required to lift the bucket 10 meters by raising the cable 10 meters? (The top half of the cable ends up at the height of the top end of the cable, while the bottom half of the cable is lifted 10 meters.)  $\Rightarrow$

## 9.6 CENTER OF MASS

Suppose a beam is 10 meters long, and that there are three weights on the beam: a 10 kilogram weight 3 meters from the left end, a 5 kilogram weight 6 meters from the left end, and a 4 kilogram weight 8 meters from the left end. Where should a fulcrum be placed so that the beam balances? Let's assign a scale to the beam, from 0 at the left end to 10 at the right, so that we can denote locations on the beam simply as  $x$  coordinates; the weights are at  $x = 3$ ,  $x = 6$ , and  $x = 8$ , as in figure 9.6.1.

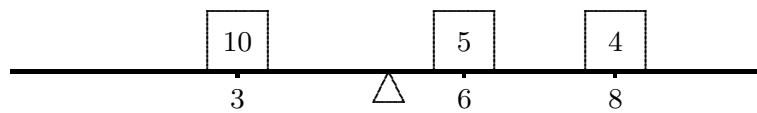
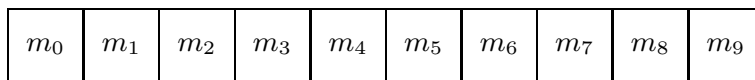

Figure 9.6.1 A beam with three masses.

Suppose to begin with that the fulcrum is placed at  $x = 5$ . What will happen? Each weight applies a force to the beam that tends to rotate it around the fulcrum; this effect is measured by a quantity called **torque**, proportional to the mass times the distance from the fulcrum. Of course, weights on different sides of the fulcrum rotate the beam in opposite directions. We can distinguish this by using a signed distance in the formula for torque. So with the fulcrum at 5, the torques induced by the three weights will be proportional to  $(3 - 5)10 = -20$ ,  $(6 - 5)5 = 5$ , and  $(8 - 5)4 = 12$ . For the beam to balance, the sum of the torques must be zero; since the sum is  $-20 + 5 + 12 = -3$ , the beam rotates counter-clockwise, and to get the beam to balance we need to move the fulcrum to the left. To calculate exactly where the fulcrum should be, we let  $\bar{x}$  denote the location of the fulcrum when the beam is in balance. The total torque on the beam is then

$(3 - \bar{x})10 + (6 - \bar{x})5 + (8 - \bar{x})4 = 92 - 19\bar{x}$ . Since the beam balances at  $\bar{x}$  it must be that  $92 - 19\bar{x} = 0$  or  $\bar{x} = 92/19 \approx 4.84$ , that is, the fulcrum should be placed at  $x = 92/19$  to balance the beam.

Now suppose that we have a beam with varying density—some portions of the beam contain more mass than other portions of the same size. We want to figure out where to put the fulcrum so that the beam balances.



**Figure 9.6.2** A solid beam.

**EXAMPLE 9.6.1** Suppose the beam is 10 meters long and that the density is  $1 + x$  kilograms per meter at location  $x$  on the beam. To approximate the solution, we can think of the beam as a sequence of weights “on” a beam. For example, we can think of the portion of the beam between  $x = 0$  and  $x = 1$  as a weight sitting at  $x = 0$ , the portion between  $x = 1$  and  $x = 2$  as a weight sitting at  $x = 1$ , and so on, as indicated in figure 9.6.2. We then approximate the mass of the weights by assuming that each portion of the beam has constant density. So the mass of the first weight is approximately  $m_0 = (1 + 0)1 = 1$  kilograms, namely,  $(1 + 0)$  kilograms per meter times 1 meter. The second weight is  $m_1 = (1 + 1)1 = 2$  kilograms, and so on to the tenth weight with  $m_9 = (1 + 9)1 = 10$  kilograms. So in this case the total torque is

$$(0 - \bar{x})m_0 + (1 - \bar{x})m_1 + \cdots + (9 - \bar{x})m_9 = (0 - \bar{x})1 + (1 - \bar{x})2 + \cdots + (9 - \bar{x})10.$$

If we set this to zero and solve for  $\bar{x}$  we get  $\bar{x} = 6$ . In general, if we divide the beam into  $n$  portions, the mass of weight number  $i$  will be  $m_i = (1 + x_i)(x_{i+1} - x_i) = (1 + x_i)\Delta x$  and the torque induced by weight number  $i$  will be  $(x_i - \bar{x})m_i = (x_i - \bar{x})(1 + x_i)\Delta x$ . The total torque is then

$$\begin{aligned} & (x_0 - \bar{x})(1 + x_0)\Delta x + (x_1 - \bar{x})(1 + x_1)\Delta x + \cdots + (x_{n-1} - \bar{x})(1 + x_{n-1})\Delta x \\ &= \sum_{i=0}^{n-1} x_i(1 + x_i)\Delta x - \sum_{i=0}^{n-1} \bar{x}(1 + x_i)\Delta x \\ &= \sum_{i=0}^{n-1} x_i(1 + x_i)\Delta x - \bar{x} \sum_{i=0}^{n-1} (1 + x_i)\Delta x. \end{aligned}$$



If we set this equal to zero and solve for  $\bar{x}$  we get an approximation to the balance point of the beam:

$$\begin{aligned}
 0 &= \sum_{i=0}^{n-1} x_i(1+x_i)\Delta x - \bar{x} \sum_{i=0}^{n-1} (1+x_i)\Delta x \\
 \bar{x} \sum_{i=0}^{n-1} (1+x_i)\Delta x &= \sum_{i=0}^{n-1} x_i(1+x_i)\Delta x \\
 \bar{x} &= \frac{\sum_{i=0}^{n-1} x_i(1+x_i)\Delta x}{\sum_{i=0}^{n-1} (1+x_i)\Delta x}.
 \end{aligned}$$

The denominator of this fraction has a very familiar interpretation. Consider one term of the sum in the denominator:  $(1+x_i)\Delta x$ . This is the density near  $x_i$  times a short length,  $\Delta x$ , which in other words is approximately the mass of the beam between  $x_i$  and  $x_{i+1}$ . When we add these up we get approximately the mass of the beam.

Now each of the sums in the fraction has the right form to turn into an integral, which in turn gives us the exact value of  $\bar{x}$ :

$$\bar{x} = \frac{\int_0^{10} x(1+x) dx}{\int_0^{10} (1+x) dx}.$$

The numerator of this fraction is called the **moment** of the system around zero:

$$\int_0^{10} x(1+x) dx = \int_0^{10} x + x^2 dx = \frac{1150}{3},$$

and the denominator is the mass of the beam:

$$\int_0^{10} (1+x) dx = 60,$$

and the balance point, officially called the **center of mass**, is

$$\bar{x} = \frac{1150}{3} \frac{1}{60} = \frac{115}{18} \approx 6.39.$$

□

It should be apparent that there was nothing special about the density function  $\sigma(x) = 1 + x$  or the length of the beam, or even that the left end of the beam is at the origin. In general, if the density of the beam is  $\sigma(x)$  and the beam covers the interval  $[a, b]$ , the moment of the beam around zero is

$$M_0 = \int_a^b x\sigma(x) dx$$

and the total mass of the beam is

$$M = \int_a^b \sigma(x) dx$$

and the center of mass is at

$$\bar{x} = \frac{M_0}{M}.$$

**EXAMPLE 9.6.2** Suppose a beam lies on the  $x$ -axis between 20 and 30, and has density function  $\sigma(x) = x - 19$ . Find the center of mass. This is the same as the previous example except that the beam has been moved. Note that the density at the left end is  $20 - 19 = 1$  and at the right end is  $30 - 19 = 11$ , as before. Hence the center of mass must be at approximately  $20 + 6.39 = 26.39$ . Let's see how the calculation works out.

$$M_0 = \int_{20}^{30} x(x - 19) dx = \int_{20}^{30} x^2 - 19x dx = \left. \frac{x^3}{3} - \frac{19x^2}{2} \right|_{20}^{30} = \frac{4750}{3}$$

$$M = \int_{20}^{30} x - 19 dx = \left. \frac{x^2}{2} - 19x \right|_{20}^{30} = 60$$

$$\frac{M_0}{M} = \frac{4750}{3} \frac{1}{60} = \frac{475}{18} \approx 26.39.$$

□

**EXAMPLE 9.6.3** Suppose a flat plate of uniform density has the shape contained by  $y = x^2$ ,  $y = 1$ , and  $x = 0$ , in the first quadrant. Find the center of mass. (Since the density is constant, the center of mass depends only on the shape of the plate, not the density, or in other words, this is a purely geometric quantity. In such a case the center of mass is called the **centroid**.)

This is a two dimensional problem, but it can be solved as if it were two one dimensional problems: we need to find the  $x$  and  $y$  coordinates of the center of mass,  $\bar{x}$  and  $\bar{y}$ , and fortunately we can do these independently. Imagine looking at the plate edge on, from below the  $x$ -axis. The plate will appear to be a beam, and the mass of a short section

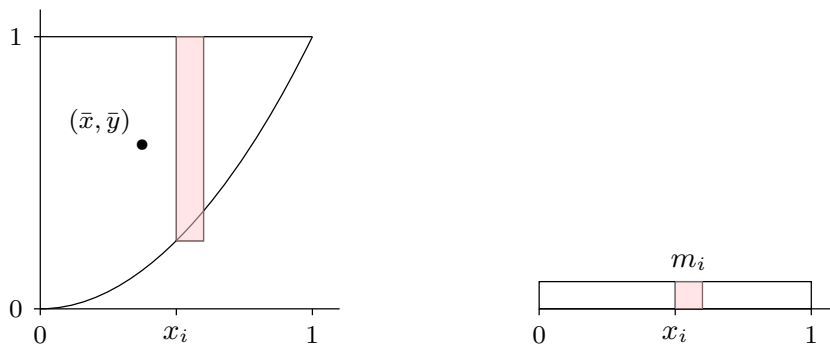

**Figure 9.6.3** Center of mass for a two dimensional plate.

of the “beam”, say between  $x_i$  and  $x_{i+1}$ , is the mass of a strip of the plate between  $x_i$  and  $x_{i+1}$ . See figure 9.6.3 showing the plate from above and as it appears edge on. Since the plate has uniform density we may as well assume that  $\sigma = 1$ . Then the mass of the plate between  $x_i$  and  $x_{i+1}$  is approximately  $m_i = \sigma(1 - x_i^2)\Delta x = (1 - x_i^2)\Delta x$ . Now we can compute the moment around the  $y$ -axis:

$$M_y = \int_0^1 x(1 - x^2) dx = \frac{1}{4}$$

and the total mass

$$M = \int_0^1 (1 - x^2) dx = \frac{2}{3}$$

and finally

$$\bar{x} = \frac{1}{4} \frac{3}{2} = \frac{3}{8}.$$

Next we do the same thing to find  $\bar{y}$ . The mass of the plate between  $y_i$  and  $y_{i+1}$  is approximately  $n_i = \sqrt{y}\Delta y$ , so

$$M_x = \int_0^1 y\sqrt{y} dy = \frac{2}{5}$$

and

$$\bar{y} = \frac{2}{5} \frac{3}{2} = \frac{3}{5},$$

since the total mass  $M$  is the same. The center of mass is shown in figure 9.6.3.  $\square$

**EXAMPLE 9.6.4** Find the center of mass of a thin, uniform plate whose shape is the region between  $y = \cos x$  and the  $x$ -axis between  $x = -\pi/2$  and  $x = \pi/2$ . It is clear

that  $\bar{x} = 0$ , but for practice let's compute it anyway. We will need the total mass, so we compute it first:

$$M = \int_{-\pi/2}^{\pi/2} \cos x \, dx = \sin x \Big|_{-\pi/2}^{\pi/2} = 2.$$

The moment around the  $y$ -axis is

$$M_y = \int_{-\pi/2}^{\pi/2} x \cos x \, dx = \cos x + x \sin x \Big|_{-\pi/2}^{\pi/2} = 0$$

and the moment around the  $x$ -axis is

$$M_x = \int_0^1 y \cdot 2 \arccos y \, dy = y^2 \arccos y - \frac{y\sqrt{1-y^2}}{2} + \frac{\arcsin y}{2} \Big|_0^1 = \frac{\pi}{4}.$$

Thus

$$\bar{x} = \frac{0}{2}, \quad \bar{y} = \frac{\pi}{8} \approx 0.393. \quad \square$$

### Exercises 9.6.

1. A beam 10 meters long has density  $\sigma(x) = x^2$  at distance  $x$  from the left end of the beam. Find the center of mass  $\bar{x}$ .  $\Rightarrow$
2. A beam 10 meters long has density  $\sigma(x) = \sin(\pi x/10)$  at distance  $x$  from the left end of the beam. Find the center of mass  $\bar{x}$ .  $\Rightarrow$
3. A beam 4 meters long has density  $\sigma(x) = x^3$  at distance  $x$  from the left end of the beam. Find the center of mass  $\bar{x}$ .  $\Rightarrow$
4. Verify that  $\int 2x \arccos x \, dx = x^2 \arccos x - \frac{x\sqrt{1-x^2}}{2} + \frac{\arcsin x}{2} + C$ .
5. A thin plate lies in the region between  $y = x^2$  and the  $x$ -axis between  $x = 1$  and  $x = 2$ . Find the centroid.  $\Rightarrow$
6. A thin plate fills the upper half of the unit circle  $x^2 + y^2 = 1$ . Find the centroid.  $\Rightarrow$
7. A thin plate lies in the region contained by  $y = x$  and  $y = x^2$ . Find the centroid.  $\Rightarrow$
8. A thin plate lies in the region contained by  $y = 4 - x^2$  and the  $x$ -axis. Find the centroid.  $\Rightarrow$
9. A thin plate lies in the region contained by  $y = x^{1/3}$  and the  $x$ -axis between  $x = 0$  and  $x = 1$ . Find the centroid.  $\Rightarrow$
10. A thin plate lies in the region contained by  $\sqrt{x} + \sqrt{y} = 1$  and the axes in the first quadrant. Find the centroid.  $\Rightarrow$
11. A thin plate lies in the region between the circle  $x^2 + y^2 = 4$  and the circle  $x^2 + y^2 = 1$ , above the  $x$ -axis. Find the centroid.  $\Rightarrow$
12. A thin plate lies in the region between the circle  $x^2 + y^2 = 4$  and the circle  $x^2 + y^2 = 1$  in the first quadrant. Find the centroid.  $\Rightarrow$
13. A thin plate lies in the region between the circle  $x^2 + y^2 = 25$  and the circle  $x^2 + y^2 = 16$  above the  $x$ -axis. Find the centroid.  $\Rightarrow$

## 9.7 KINETIC ENERGY; IMPROPER INTEGRALS

Recall example 9.5.3 in which we computed the work required to lift an object from the surface of the earth to some large distance  $D$  away. Since  $F = k/x^2$  we computed

$$\int_{r_0}^D \frac{k}{x^2} dx = -\frac{k}{D} + \frac{k}{r_0}.$$

We noticed that as  $D$  increases,  $k/D$  decreases to zero so that the amount of work increases to  $k/r_0$ . More precisely,

$$\lim_{D \rightarrow \infty} \int_{r_0}^D \frac{k}{x^2} dx = \lim_{D \rightarrow \infty} -\frac{k}{D} + \frac{k}{r_0} = \frac{k}{r_0}.$$

We might reasonably describe this calculation as computing the amount of work required to lift the object “to infinity,” and abbreviate the limit as

$$\lim_{D \rightarrow \infty} \int_{r_0}^D \frac{k}{x^2} dx = \int_{r_0}^{\infty} \frac{k}{x^2} dx.$$

Such an integral, with a limit of infinity, is called an **improper integral**. This is a bit unfortunate, since it’s not really “improper” to do this, nor is it really “an integral”—it is an abbreviation for the limit of a particular sort of integral. Nevertheless, we’re stuck with the term, and the operation itself is perfectly legitimate. It may at first seem odd that a finite amount of work is sufficient to lift an object to “infinity”, but sometimes surprising things are nevertheless true, and this is such a case. If the value of an improper integral is a finite number, as in this example, we say that the integral **converges**, and if not we say that the integral **diverges**.

Here’s another way, perhaps even more surprising, to interpret this calculation. We know that one interpretation of

$$\int_1^D \frac{1}{x^2} dx$$

is the area under  $y = 1/x^2$  from  $x = 1$  to  $x = D$ . Of course, as  $D$  increases this area increases. But since

$$\int_1^D \frac{1}{x^2} dx = -\frac{1}{D} + \frac{1}{1},$$

while the area increases, it never exceeds 1, that is

$$\int_1^{\infty} \frac{1}{x^2} dx = 1.$$

The area of the infinite region under  $y = 1/x^2$  from  $x = 1$  to infinity is finite.

Consider a slightly different sort of improper integral:  $\int_{-\infty}^{\infty} xe^{-x^2} dx$ . There are two ways we might try to compute this. First, we could break it up into two more familiar integrals:

$$\int_{-\infty}^{\infty} xe^{-x^2} dx = \int_{-\infty}^0 xe^{-x^2} dx + \int_0^{\infty} xe^{-x^2} dx.$$

Now we do these as before:

$$\int_{-\infty}^0 xe^{-x^2} dx = \lim_{D \rightarrow \infty} \left. -\frac{e^{-x^2}}{2} \right|_D^0 = -\frac{1}{2},$$

and

$$\int_0^{\infty} xe^{-x^2} dx = \lim_{D \rightarrow \infty} \left. -\frac{e^{-x^2}}{2} \right|_0^D = \frac{1}{2},$$

so

$$\int_{-\infty}^{\infty} xe^{-x^2} dx = -\frac{1}{2} + \frac{1}{2} = 0.$$

Alternately, we might try

$$\int_{-\infty}^{\infty} xe^{-x^2} dx = \lim_{D \rightarrow \infty} \int_{-D}^D xe^{-x^2} dx = \lim_{D \rightarrow \infty} \left. -\frac{e^{-x^2}}{2} \right|_{-D}^D = \lim_{D \rightarrow \infty} -\frac{e^{-D^2}}{2} + \frac{e^{-D^2}}{2} = 0.$$

So we get the same answer either way. This does not always happen; sometimes the second approach gives a finite number, while the first approach does not; the exercises provide examples. In general, we interpret the integral  $\int_{-\infty}^{\infty} f(x) dx$  according to the first method:

both integrals  $\int_{-\infty}^a f(x) dx$  and  $\int_a^{\infty} f(x) dx$  must converge for the original integral to

converge. The second approach does turn out to be useful; when  $\lim_{D \rightarrow \infty} \int_{-D}^D f(x) dx = L$ ,

and  $L$  is finite, then  $L$  is called the **Cauchy Principal Value** of  $\int_{-\infty}^{\infty} f(x) dx$ .

Here's a more concrete application of these ideas. We know that in general

$$W = \int_{x_0}^{x_1} F dx$$

is the work done against the force  $F$  in moving from  $x_0$  to  $x_1$ . In the case that  $F$  is the force of gravity exerted by the earth, it is customary to make  $F < 0$  since the force is

“downward.” This makes the work  $W$  negative when it should be positive, so typically the work in this case is defined as

$$W = - \int_{x_0}^{x_1} F dx.$$

Also, by Newton’s Law,  $F = ma(t)$ . This means that

$$W = - \int_{x_0}^{x_1} ma(t) dx.$$

Unfortunately this integral is a bit problematic:  $a(t)$  is in terms of  $t$ , while the limits and the “ $dx$ ” are in terms of  $x$ . But  $x$  and  $t$  are certainly related here:  $x = x(t)$  is the function that gives the position of the object at time  $t$ , so  $v = v(t) = dx/dt = x'(t)$  is its velocity and  $a(t) = v'(t) = x''(t)$ . We can use  $v = x'(t)$  as a substitution to convert the integral from “ $dx$ ” to “ $dv$ ” in the usual way, with a bit of cleverness along the way:

$$\begin{aligned} dv &= x''(t) dt = a(t) dt = a(t) \frac{dt}{dx} dx \\ \frac{dx}{dt} dv &= a(t) dx \\ v dv &= a(t) dx. \end{aligned}$$

Substituting in the integral:

$$W = - \int_{x_0}^{x_1} ma(t) dx = - \int_{v_0}^{v_1} mv dv = - \left. \frac{mv^2}{2} \right|_{v_0}^{v_1} = - \frac{mv_1^2}{2} + \frac{mv_0^2}{2}.$$

You may recall seeing the expression  $mv^2/2$  in a physics course—it is called the **kinetic energy** of the object. We have shown here that the work done in moving the object from one place to another is the same as the change in kinetic energy.

We know that the work required to move an object from the surface of the earth to infinity is

$$W = \int_{r_0}^{\infty} \frac{k}{r^2} dr = \frac{k}{r_0}.$$

At the surface of the earth the acceleration due to gravity is approximately 9.8 meters per second squared, so the force on an object of mass  $m$  is  $F = 9.8m$ . The radius of the earth is approximately 6378.1 kilometers or 6378100 meters. Since the force due to gravity obeys an inverse square law,  $F = k/r^2$  and  $9.8m = k/6378100^2$ ,  $k = 398665564178000m$  and  $W = 62505380m$ .

Now suppose that the initial velocity of the object,  $v_0$ , is just enough to get it to infinity, that is, just enough so that the object never slows to a stop, but so that its speed decreases to zero, i.e., so that  $v_1 = 0$ . Then

$$62505380m = W = -\frac{mv_1^2}{2} + \frac{mv_0^2}{2} = \frac{mv_0^2}{2}$$

so

$$v_0 = \sqrt{125010760} \approx 11181 \text{ meters per second,}$$

or about 40251 kilometers per hour. This speed is called the **escape velocity**. Notice that the mass of the object,  $m$ , canceled out at the last step; the escape velocity is the same for all objects. Of course, it takes considerably more energy to get a large object up to 40251 kph than a small one, so it is certainly more difficult to get a large object into deep space than a small one. Also, note that while we have computed the escape velocity for the earth, this speed would not in fact get an object “to infinity” because of the large mass in our neighborhood called the sun. Escape velocity for the sun *starting at the distance of the earth from the sun* is nearly 4 times the escape velocity we have calculated.

### Exercises 9.7.

1. Is the area under  $y = 1/x$  from 1 to infinity finite or infinite? If finite, compute the area.  $\Rightarrow$
2. Is the area under  $y = 1/x^3$  from 1 to infinity finite or infinite? If finite, compute the area.  $\Rightarrow$
3. Does  $\int_0^{\infty} x^2 + 2x - 1 dx$  converge or diverge? If it converges, find the value.  $\Rightarrow$
4. Does  $\int_1^{\infty} 1/\sqrt{x} dx$  converge or diverge? If it converges, find the value.  $\Rightarrow$
5. Does  $\int_0^{\infty} e^{-x} dx$  converge or diverge? If it converges, find the value.  $\Rightarrow$
6.  $\int_0^{1/2} (2x - 1)^{-3} dx$  is an improper integral of a slightly different sort. Express it as a limit and determine whether it converges or diverges; if it converges, find the value.  $\Rightarrow$
7. Does  $\int_0^1 1/\sqrt{x} dx$  converge or diverge? If it converges, find the value.  $\Rightarrow$
8. Does  $\int_0^{\pi/2} \sec^2 x dx$  converge or diverge? If it converges, find the value.  $\Rightarrow$
9. Does  $\int_{-\infty}^{\infty} \frac{x^2}{4 + x^6} dx$  converge or diverge? If it converges, find the value.  $\Rightarrow$
10. Does  $\int_{-\infty}^{\infty} x dx$  converge or diverge? If it converges, find the value. Also find the Cauchy Principal Value, if it exists.  $\Rightarrow$
11. Does  $\int_{-\infty}^{\infty} \sin x dx$  converge or diverge? If it converges, find the value. Also find the Cauchy Principal Value, if it exists.  $\Rightarrow$



12. Does  $\int_{-\infty}^{\infty} \cos x \, dx$  converge or diverge? If it converges, find the value. Also find the Cauchy Principal Value, if it exists.  $\Rightarrow$
13. Suppose the curve  $y = 1/x$  is rotated around the  $x$ -axis generating a sort of funnel or horn shape, called **Gabriel's horn** or **Toricelli's trumpet**. Is the volume of this funnel from  $x = 1$  to infinity finite or infinite? If finite, compute the volume.  $\Rightarrow$
14. An officially sanctioned baseball must be between 142 and 149 grams. How much work, in Newton-meters, does it take to throw a ball at 80 miles per hour? At 90 mph? At 100.9 mph? (According to the Guinness Book of World Records, at [http://www.baseball-almanac.com/recbooks/rb\\_guin.shtml](http://www.baseball-almanac.com/recbooks/rb_guin.shtml), "The greatest reliably recorded speed at which a baseball has been pitched is 100.9 mph by Lynn Nolan Ryan (California Angels) at Anaheim Stadium in California on August 20, 1974.")  $\Rightarrow$

## 9.8 PROBABILITY

You perhaps have at least a rudimentary understanding of **discrete probability**, which measures the likelihood of an "event" when there are a finite number of possibilities. For example, when an ordinary six-sided die is rolled, the probability of getting any particular number is  $1/6$ . In general, the probability of an event is the number of ways the event can happen divided by the number of ways that "anything" can happen.

For a slightly more complicated example, consider the case of two six-sided dice. The dice are physically distinct, which means that rolling a 2–5 is different than rolling a 5–2; each is an equally likely event out of a total of 36 ways the dice can land, so each has a probability of  $1/36$ .

Most interesting events are not so simple. More interesting is the probability of rolling a certain sum out of the possibilities 2 through 12. It is clearly not true that all sums are equally likely: the only way to roll a 2 is to roll 1–1, while there are many ways to roll a 7. Because the number of possibilities is quite small, and because a pattern quickly becomes evident, it is easy to see that the probabilities of the various sums are:

$$P(2) = P(12) = 1/36$$

$$P(3) = P(11) = 2/36$$

$$P(4) = P(10) = 3/36$$

$$P(5) = P(9) = 4/36$$

$$P(6) = P(8) = 5/36$$

$$P(7) = 6/36$$

Here we use  $P(n)$  to mean "the probability of rolling an  $n$ ." Since we have correctly accounted for all possibilities, the sum of all these probabilities is  $36/36 = 1$ ; the probability that the sum is one of 2 through 12 is 1, because there are no other possibilities.

The study of probability is concerned with more difficult questions as well; for example, suppose the two dice are rolled many times. On the average, what sum will come up? In the language of probability, this average is called the **expected value** of the sum. This is at first a little misleading, as it does not tell us what to “expect” when the two dice are rolled, but what we expect the long term average will be.

Suppose that two dice are rolled 36 million times. Based on the probabilities, we would expect about 1 million rolls to be 2, about 2 million to be 3, and so on, with a roll of 7 topping the list at about 6 million. The sum of all rolls would be 1 million times 2 plus 2 million times 3, and so on, and dividing by 36 million we would get the average:

$$\begin{aligned}\bar{x} &= (2 \cdot 10^6 + 3(2 \cdot 10^6) + \cdots + 7(6 \cdot 10^6) + \cdots + 12 \cdot 10^6) \frac{1}{36 \cdot 10^6} \\ &= 2 \frac{10^6}{36 \cdot 10^6} + 3 \frac{2 \cdot 10^6}{36 \cdot 10^6} + \cdots + 7 \frac{6 \cdot 10^6}{36 \cdot 10^6} + \cdots + 12 \frac{10^6}{36 \cdot 10^6} \\ &= 2P(2) + 3P(3) + \cdots + 7P(7) + \cdots + 12P(12) \\ &= \sum_{i=2}^{12} iP(i) = 7.\end{aligned}$$

There is nothing special about the 36 million in this calculation. No matter what the number of rolls, once we simplify the average, we get the same  $\sum_{i=2}^{12} iP(i)$ . While the actual average value of a large number of rolls will not be exactly 7, the average should be close to 7 when the number of rolls is large. Turning this around, if the average is not close to 7, we should suspect that the dice are not fair.

A variable, say  $X$ , that can take certain values, each with a corresponding probability, is called a **random variable**; in the example above, the random variable was the sum of the two dice. If the possible values for  $X$  are  $x_1, x_2, \dots, x_n$ , then the expected value of the random variable is  $E(X) = \sum_{i=1}^n x_i P(x_i)$ . The expected value is also called the **mean**.

When the number of possible values for  $X$  is finite, we say that  $X$  is a discrete random variable. In many applications of probability, the number of possible values of a random variable is very large, perhaps even infinite. To deal with the infinite case we need a different approach, and since there is a sum involved, it should not be wholly surprising that integration turns out to be a useful tool. It then turns out that even when the number of possibilities is large but finite, it is frequently easier to pretend that the number is infinite. Suppose, for example, that a dart is thrown at a dart board. Since the dart board consists of a finite number of atoms, there are in some sense only a finite number of places for the dart to land, but it is easier to explore the probabilities involved by pretending that the dart can land on any point in the usual  $x$ - $y$  plane.

**DEFINITION 9.8.1** Let  $f : \mathbb{R} \rightarrow \mathbb{R}$  be a function. If  $f(x) \geq 0$  for every  $x$  and  $\int_{-\infty}^{\infty} f(x) dx = 1$  then  $f$  is a **probability density function**.  $\square$

We associate a probability density function with a random variable  $X$  by stipulating that the probability that  $X$  is between  $a$  and  $b$  is  $\int_a^b f(x) dx$ . Because of the requirement that the integral from  $-\infty$  to  $\infty$  be 1, all probabilities are less than or equal to 1, and the probability that  $X$  takes on some value between  $-\infty$  and  $\infty$  is 1, as it should be.

**EXAMPLE 9.8.2** Consider again the two dice example; we can view it in a way that more resembles the probability density function approach. Consider a random variable  $X$  that takes on any real value with probabilities given by the probability density function in figure 9.8.1. The function  $f$  consists of just the top edges of the rectangles, with vertical sides drawn for clarity; the function is zero below 1.5 and above 12.5. The area of each rectangle is the probability of rolling the sum in the middle of the bottom of the rectangle, or

$$P(n) = \int_{n-1/2}^{n+1/2} f(x) dx.$$

The probability of rolling a 4, 5, or 6 is

$$P(n) = \int_{7/2}^{13/2} f(x) dx.$$

Of course, we could also compute probabilities that don't make sense in the context of the dice, such as the probability that  $X$  is between 4 and 5.8.  $\square$

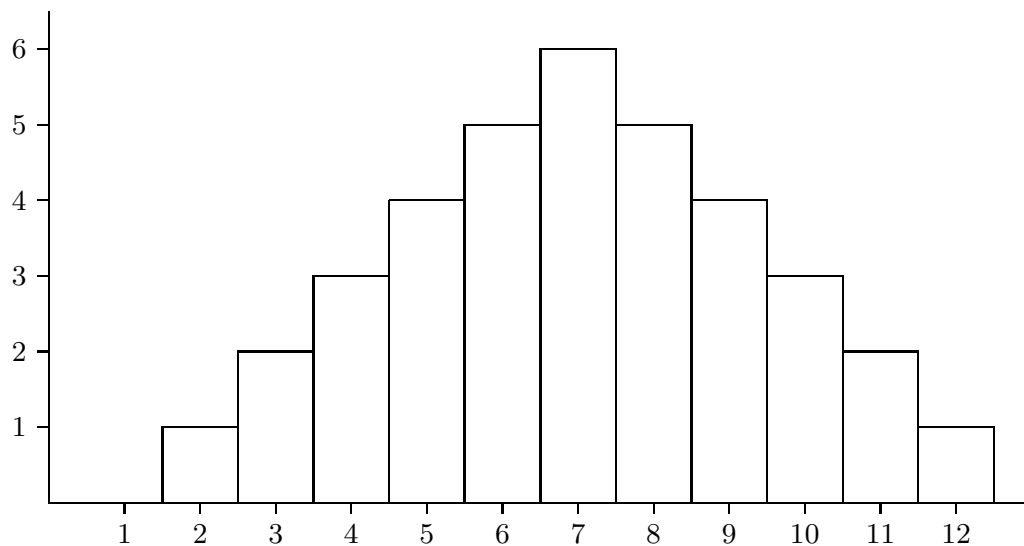

**Figure 9.8.1** A probability density function for two dice.

The function

$$F(x) = P(X \leq x) = \int_{-\infty}^x f(t) dt$$

is called the **cumulative distribution function** or simply (probability) distribution.

**EXAMPLE 9.8.3** Suppose that  $a < b$  and

$$f(x) = \begin{cases} \frac{1}{b-a} & \text{if } a \leq x \leq b \\ 0 & \text{otherwise.} \end{cases}$$

Then  $f(x)$  is the **uniform probability density function** on  $[a, b]$ . and the corresponding distribution is the **uniform distribution** on  $[a, b]$ .  $\square$

**EXAMPLE 9.8.4** Consider the function  $f(x) = e^{-x^2/2}$ . What can we say about

$$\int_{-\infty}^{\infty} e^{-x^2/2} dx?$$

We cannot find an antiderivative of  $f$ , but we can see that this integral is some finite number. Notice that  $0 < f(x) = e^{-x^2/2} \leq e^{-x/2}$  for  $|x| > 1$ . This implies that the area under  $e^{-x^2/2}$  is less than the area under  $e^{-x/2}$ , over the interval  $[1, \infty)$ . It is easy to compute the latter area, namely

$$\int_1^{\infty} e^{-x/2} dx = \frac{2}{\sqrt{e}},$$

so

$$\int_1^{\infty} e^{-x^2/2} dx$$

is some finite number smaller than  $2/\sqrt{e}$ . Because  $f$  is symmetric around the  $y$ -axis,

$$\int_{-\infty}^{-1} e^{-x^2/2} dx = \int_1^{\infty} e^{-x^2/2} dx.$$

This means that

$$\int_{-\infty}^{\infty} e^{-x^2/2} dx = \int_{-\infty}^{-1} e^{-x^2/2} dx + \int_{-1}^1 e^{-x^2/2} dx + \int_1^{\infty} e^{-x^2/2} dx = A$$

for some finite positive number  $A$ . Now if we let  $g(x) = f(x)/A$ ,

$$\int_{-\infty}^{\infty} g(x) dx = \frac{1}{A} \int_{-\infty}^{\infty} e^{-x^2/2} dx = \frac{1}{A} A = 1,$$

so  $g$  is a probability density function. It turns out to be very useful, and is called the **standard normal probability density function** or more informally the **bell curve**,

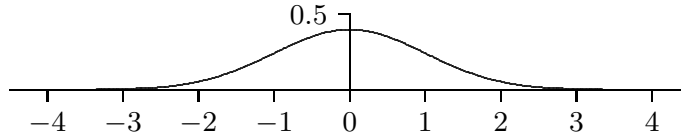

**Figure 9.8.2** The bell curve.

giving rise to the **standard normal distribution**. See figure 9.8.2 for the graph of the bell curve.  $\square$

We have shown that  $A$  is some finite number without computing it; we cannot compute it with the techniques we have available. By using some techniques from multivariable calculus, it can be shown that  $A = \sqrt{2\pi}$ .

**EXAMPLE 9.8.5** The **exponential distribution** has probability density function

$$f(x) = \begin{cases} 0 & x < 0 \\ ce^{-cx} & x \geq 0 \end{cases}$$

where  $c$  is a positive constant.  $\square$

The mean or expected value of a random variable is quite useful, as hinted at in our discussion of dice. Recall that the mean for a discrete random variable is  $E(X) = \sum_{i=1}^n x_i P(x_i)$ . In the more general context we use an integral in place of the sum.

**DEFINITION 9.8.6** The **mean** of a random variable  $X$  with probability density function  $f$  is  $\mu = E(X) = \int_{-\infty}^{\infty} xf(x) dx$ , provided the integral converges.  $\square$

When the mean exists it is unique, since it is the result of an explicit calculation. The mean does not always exist.

The mean might look familiar; it is essentially identical to the center of mass of a one-dimensional beam, as discussed in section 9.6. The probability density function  $f$  plays the role of the physical density function, but now the “beam” has infinite length. If we consider only a finite portion of the beam, say between  $a$  and  $b$ , then the center of mass is

$$\bar{x} = \frac{\int_a^b xf(x) dx}{\int_a^b f(x) dx}.$$

If we extend the beam to infinity, we get

$$\bar{x} = \frac{\int_{-\infty}^{\infty} x f(x) dx}{\int_{-\infty}^{\infty} f(x) dx} = \int_{-\infty}^{\infty} x f(x) dx = E(X),$$

because  $\int_{-\infty}^{\infty} f(x) dx = 1$ . In the center of mass interpretation, this integral is the total mass of the beam, which is always 1 when  $f$  is a probability density function.

**EXAMPLE 9.8.7** The mean of the standard normal distribution is

$$\int_{-\infty}^{\infty} x \frac{e^{-x^2/2}}{\sqrt{2\pi}} dx.$$

We compute the two halves:

$$\int_{-\infty}^0 x \frac{e^{-x^2/2}}{\sqrt{2\pi}} dx = \lim_{D \rightarrow -\infty} -\frac{e^{-x^2/2}}{\sqrt{2\pi}} \Big|_D^0 = -\frac{1}{\sqrt{2\pi}}$$

and

$$\int_0^{\infty} x \frac{e^{-x^2/2}}{\sqrt{2\pi}} dx = \lim_{D \rightarrow \infty} -\frac{e^{-x^2/2}}{\sqrt{2\pi}} \Big|_0^D = \frac{1}{\sqrt{2\pi}}.$$

The sum of these is 0, which is the mean. □

While the mean is very useful, it typically is not enough information to properly evaluate a situation. For example, suppose we could manufacture an 11-sided die, with the faces numbered 2 through 12 so that each face is equally likely to be down when the die is rolled. The value of a roll is the value on this lower face. Rolling the die gives the same range of values as rolling two ordinary dice, but now each value occurs with probability  $1/11$ . The expected value of a roll is

$$\frac{2}{11} + \frac{3}{11} + \cdots + \frac{12}{11} = 7.$$

The mean does not distinguish the two cases, though of course they are quite different.

If  $f$  is a probability density function for a random variable  $X$ , with mean  $\mu$ , we would like to measure how far a “typical” value of  $X$  is from  $\mu$ . One way to measure this distance

is  $(X - \mu)^2$ ; we square the difference so as to measure all distances as positive. To get the typical such squared distance, we compute the mean. For two dice, for example, we get

$$(2 - 7)^2 \frac{1}{36} + (3 - 7)^2 \frac{2}{36} + \cdots + (7 - 7)^2 \frac{6}{36} + \cdots + (11 - 7)^2 \frac{2}{36} + (12 - 7)^2 \frac{1}{36} = \frac{35}{36}.$$

Because we squared the differences this does not directly measure the typical distance we seek; if we take the square root of this we do get such a measure,  $\sqrt{35/36} \approx 2.42$ . Doing the computation for the strange 11-sided die we get

$$(2 - 7)^2 \frac{1}{11} + (3 - 7)^2 \frac{1}{11} + \cdots + (7 - 7)^2 \frac{1}{11} + \cdots + (11 - 7)^2 \frac{1}{11} + (12 - 7)^2 \frac{1}{11} = 10,$$

with square root approximately 3.16. Comparing 2.42 to 3.16 tells us that the two-dice rolls clump somewhat more closely near 7 than the rolls of the weird die, which of course we already knew because these examples are quite simple.

To perform the same computation for a probability density function the sum is replaced by an integral, just as in the computation of the mean. The expected value of the squared distances is

$$V(X) = \int_{-\infty}^{\infty} (x - \mu)^2 f(x) dx,$$

called the **variance**. The square root of the variance is the **standard deviation**, denoted  $\sigma$ .

**EXAMPLE 9.8.8** We compute the standard deviation of the standard normal distribution. The variance is

$$\frac{1}{\sqrt{2\pi}} \int_{-\infty}^{\infty} x^2 e^{-x^2/2} dx.$$

To compute the antiderivative, use integration by parts, with  $u = x$  and  $dv = x e^{-x^2/2} dx$ . This gives

$$\int x^2 e^{-x^2/2} dx = -x e^{-x^2/2} + \int e^{-x^2/2} dx.$$

We cannot do the new integral, but we know its value when the limits are  $-\infty$  to  $\infty$ , from our discussion of the standard normal distribution. Thus

$$\frac{1}{\sqrt{2\pi}} \int_{-\infty}^{\infty} x^2 e^{-x^2/2} dx = -\frac{1}{\sqrt{2\pi}} x e^{-x^2/2} \Big|_{-\infty}^{\infty} + \frac{1}{\sqrt{2\pi}} \int_{-\infty}^{\infty} e^{-x^2/2} dx = 0 + \frac{1}{\sqrt{2\pi}} \sqrt{2\pi} = 1.$$

The standard deviation is then  $\sqrt{1} = 1$ . □

Here is a simple example showing how these ideas can be useful. Suppose it is known that, in the long run, 1 out of every 100 computer memory chips produced by a certain

manufacturing plant is defective when the manufacturing process is running correctly. Suppose 1000 chips are selected at random and 15 of them are defective. This is more than the ‘expected’ number (10), but is it so many that we should suspect that something has gone wrong in the manufacturing process? We are interested in the probability that various numbers of defective chips arise; the probability distribution is discrete: there can only be a whole number of defective chips. But (under reasonable assumptions) the distribution is very close to a normal distribution, namely this one:

$$f(x) = \frac{1}{\sqrt{2\pi}\sqrt{1000(.01)(.99)}} \exp\left(\frac{-(x-10)^2}{2(1000)(.01)(.99)}\right),$$

which is pictured in figure 9.8.3 (recall that  $\exp(x) = e^x$ ).

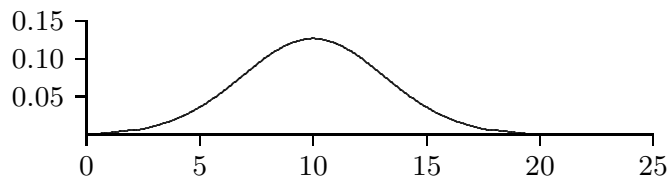

**Figure 9.8.3** Normal density function for the defective chips example.

Now how do we measure how unlikely it is that under normal circumstances we would see 15 defective chips? We can’t compute the probability of exactly 15 defective chips, as this would be  $\int_{15}^{15} f(x) dx = 0$ . We could compute  $\int_{14.5}^{15.5} f(x) dx \approx 0.036$ ; this means there is only a 3.6% chance that the number of defective chips is 15. (We cannot compute these integrals exactly; computer software has been used to approximate the integral values in this discussion.) But this is misleading:  $\int_{9.5}^{10.5} f(x) dx \approx 0.126$ , which is larger, certainly, but still small, even for the “most likely” outcome. The most useful question, in most circumstances, is this: how likely is it that the number of defective chips is “far from” the mean? For example, how likely, or unlikely, is it that the number of defective chips is different by 5 or more from the expected value of 10? This is the probability that the number of defective chips is less than 5 or larger than 15, namely

$$\int_{-\infty}^5 f(x) dx + \int_{15}^{\infty} f(x) dx \approx 0.11.$$

So there is an 11% chance that this happens—not large, but not tiny. Hence the 15 defective chips does not appear to be cause for alarm: about one time in nine we would expect to see the number of defective chips 5 or more away from the expected 10. How



about 20? Here we compute

$$\int_{-\infty}^0 f(x) dx + \int_{20}^{\infty} f(x) dx \approx 0.0015.$$

So there is only a 0.15% chance that the number of defective chips is more than 10 away from the mean; this would typically be interpreted as too suspicious to ignore—it shouldn't happen if the process is running normally.

The big question, of course, is what level of improbability should trigger concern? It depends to some degree on the application, and in particular on the consequences of getting it wrong in one direction or the other. If we're wrong, do we lose a little money? A lot of money? Do people die? In general, the standard choices are 5% and 1%. So what we should do is find the number of defective chips that has only, let us say, a 1% chance of occurring under normal circumstances, and use that as the relevant number. In other words, we want to know when

$$\int_{-\infty}^{10-r} f(x) dx + \int_{10+r}^{\infty} f(x) dx < 0.01.$$

A bit of trial and error shows that with  $r = 8$  the value is about 0.011, and with  $r = 9$  it is about 0.004, so if the number of defective chips is 19 or more, or 1 or fewer, we should look for problems. If the number is high, we worry that the manufacturing process has a problem, or conceivably that the process that tests for defective chips is not working correctly and is flagging good chips as defective. If the number is too low, we suspect that the testing procedure is broken, and is not detecting defective chips.

### ***Exercises 9.8.***

1. Verify that  $\int_1^{\infty} e^{-x/2} dx = 2/\sqrt{e}$ .
2. Show that the function in example 9.8.5 is a probability density function. Compute the mean and standard deviation.  $\Rightarrow$
3. Compute the mean and standard deviation of the uniform distribution on  $[a, b]$ . (See example 9.8.3.)  $\Rightarrow$
4. What is the expected value of one roll of a fair six-sided die?  $\Rightarrow$
5. What is the expected sum of one roll of three fair six-sided dice?  $\Rightarrow$
6. Let  $\mu$  and  $\sigma$  be real numbers with  $\sigma > 0$ . Show that

$$N(x) = \frac{1}{\sqrt{2\pi}\sigma} e^{-\frac{(x-\mu)^2}{2\sigma^2}}$$

is a probability density function. You will not be able to compute this integral directly; use a substitution to convert the integral into the one from example 9.8.4. The function  $N$  is the probability density function of the **normal distribution** with mean  $\mu$  and standard

deviation  $\sigma$ . Show that the mean of the normal distribution is  $\mu$  and the standard deviation is  $\sigma$ .

7. Let

$$f(x) = \begin{cases} \frac{1}{x^2} & |x| \geq 1 \\ 0 & |x| < 1 \end{cases}$$

Show that  $f$  is a probability density function, and that the distribution has no mean.

8. Let

$$f(x) = \begin{cases} x & -1 \leq x \leq 1 \\ 1 & 1 < x \leq 2 \\ 0 & \text{otherwise.} \end{cases}$$

Show that  $\int_{-\infty}^{\infty} f(x) dx = 1$ . Is  $f$  a probability density function? Justify your answer.

9. If you have access to appropriate software, find  $r$  so that

$$\int_{-\infty}^{10+r} f(x) dx + \int_{10+r}^{\infty} f(x) dx \approx 0.05.$$

Discuss the impact of using this new value of  $r$  to decide whether to investigate the chip manufacturing process.  $\Rightarrow$

## 9.9 ARC LENGTH

Here is another geometric application of the integral: find the length of a portion of a curve. As usual, we need to think about how we might approximate the length, and turn the approximation into an integral.

We already know how to compute one simple arc length, that of a line segment. If the endpoints are  $P_0(x_0, y_0)$  and  $P_1(x_1, y_1)$  then the length of the segment is the distance between the points,  $\sqrt{(x_1 - x_0)^2 + (y_1 - y_0)^2}$ , from the Pythagorean theorem, as illustrated in figure 9.9.1.

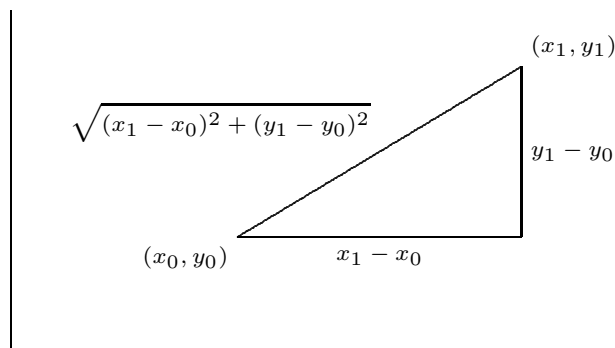

**Figure 9.9.1** The length of a line segment.

Now if the graph of  $f$  is “nice” (say, differentiable) it appears that we can approximate the length of a portion of the curve with line segments, and that as the number of segments

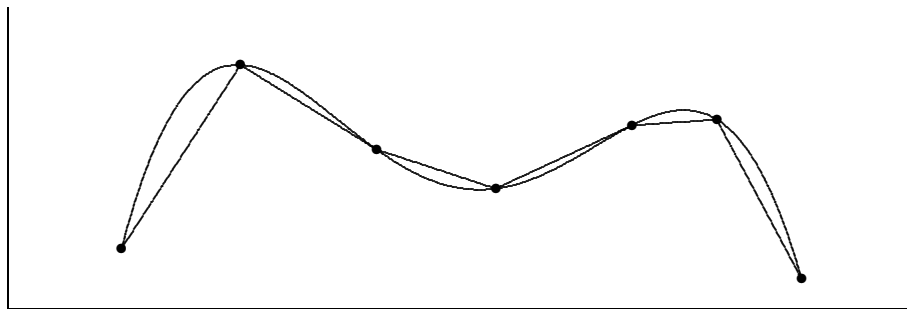

**Figure 9.9.2** Approximating arc length with line segments.

increases, and their lengths decrease, the sum of the lengths of the line segments will approach the true arc length; see figure 9.9.2.

Now we need to write a formula for the sum of the lengths of the line segments, in a form that we know becomes an integral in the limit. So we suppose we have divided the interval  $[a, b]$  into  $n$  subintervals as usual, each with length  $\Delta x = (b - a)/n$ , and endpoints  $a = x_0, x_1, x_2, \dots, x_n = b$ . The length of a typical line segment, joining  $(x_i, f(x_i))$  to  $(x_{i+1}, f(x_{i+1}))$ , is  $\sqrt{(\Delta x)^2 + (f(x_{i+1}) - f(x_i))^2}$ . By the Mean Value Theorem (6.5.2), there is a number  $t_i$  in  $(x_i, x_{i+1})$  such that  $f'(t_i)\Delta x = f(x_{i+1}) - f(x_i)$ , so the length of the line segment can be written as

$$\sqrt{(\Delta x)^2 + (f'(t_i)\Delta x)^2} = \sqrt{1 + (f'(t_i))^2} \Delta x.$$

The arc length is then

$$\lim_{n \rightarrow \infty} \sum_{i=0}^{n-1} \sqrt{1 + (f'(t_i))^2} \Delta x = \int_a^b \sqrt{1 + (f'(x))^2} dx.$$

Note that the sum looks a bit different than others we have encountered, because the approximation contains a  $t_i$  instead of an  $x_i$ . In the past we have always used left endpoints (namely,  $x_i$ ) to get a representative value of  $f$  on  $[x_i, x_{i+1}]$ ; now we are using a different point, but the principle is the same.

To summarize, to compute the length of a curve on the interval  $[a, b]$ , we compute the integral

$$\int_a^b \sqrt{1 + (f'(x))^2} dx.$$

Unfortunately, integrals of this form are typically difficult or impossible to compute exactly, because usually none of our methods for finding antiderivatives will work. In practice this means that the integral will usually have to be approximated.

**EXAMPLE 9.9.1** Let  $f(x) = \sqrt{r^2 - x^2}$ , the upper half circle of radius  $r$ . The length of this curve is half the circumference, namely  $\pi r$ . Let's compute this with the arc length formula. The derivative  $f'$  is  $-x/\sqrt{r^2 - x^2}$  so the integral is

$$\int_{-r}^r \sqrt{1 + \frac{x^2}{r^2 - x^2}} dx = \int_{-r}^r \sqrt{\frac{r^2}{r^2 - x^2}} dx = r \int_{-r}^r \sqrt{\frac{1}{r^2 - x^2}} dx.$$

Using a trigonometric substitution, we find the antiderivative, namely  $\arcsin(x/r)$ . Notice that the integral is improper at both endpoints, as the function  $\sqrt{1/(r^2 - x^2)}$  is undefined when  $x = \pm r$ . So we need to compute

$$\lim_{D \rightarrow -r^+} \int_D^0 \sqrt{\frac{1}{r^2 - x^2}} dx + \lim_{D \rightarrow r^-} \int_0^D \sqrt{\frac{1}{r^2 - x^2}} dx.$$

This is not difficult, and has value  $\pi$ , so the original integral, with the extra  $r$  in front, has value  $\pi r$  as expected.  $\square$

### Exercises 9.9.

1. Find the arc length of  $f(x) = x^{3/2}$  on  $[0, 2]$ .  $\Rightarrow$
2. Find the arc length of  $f(x) = x^2/8 - \ln x$  on  $[1, 2]$ .  $\Rightarrow$
3. Find the arc length of  $f(x) = (1/3)(x^2 + 2)^{3/2}$  on the interval  $[0, a]$ .  $\Rightarrow$
4. Find the arc length of  $f(x) = \ln(\sin x)$  on the interval  $[\pi/4, \pi/3]$ .  $\Rightarrow$
5. Let  $a > 0$ . Show that the length of  $y = \cosh x$  on  $[0, a]$  is equal to  $\int_0^a \cosh x dx$ .
6. Find the arc length of  $f(x) = \cosh x$  on  $[0, \ln 2]$ .  $\Rightarrow$
7. Set up the integral to find the arc length of  $\sin x$  on the interval  $[0, \pi]$ ; do not evaluate the integral. If you have access to appropriate software, approximate the value of the integral.  $\Rightarrow$
8. Set up the integral to find the arc length of  $y = xe^{-x}$  on the interval  $[2, 3]$ ; do not evaluate the integral. If you have access to appropriate software, approximate the value of the integral.  $\Rightarrow$
9. Find the arc length of  $y = e^x$  on the interval  $[0, 1]$ . (This can be done exactly; it is a bit tricky and a bit long.)  $\Rightarrow$

## 9.10 SURFACE AREA

Another geometric question that arises naturally is: "What is the surface area of a volume?" For example, what is the surface area of a sphere? More advanced techniques are required to approach this question in general, but we can compute the areas of some volumes generated by revolution.

As usual, the question is: how might we approximate the surface area? For a surface obtained by rotating a curve around an axis, we can take a polygonal approximation to the curve, as in the last section, and rotate it around the same axis. This gives a surface composed of many “truncated cones;” a truncated cone is called a **frustum** of a cone. Figure 9.10.1 illustrates this approximation.

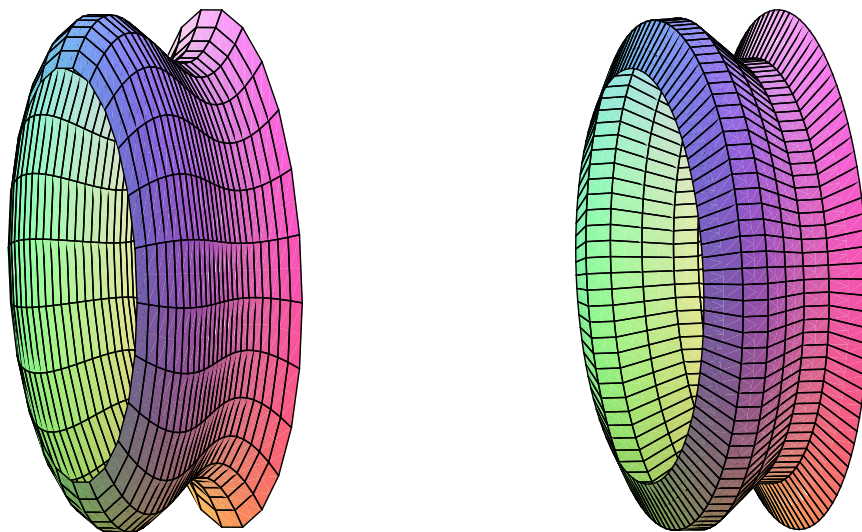

**Figure 9.10.1** Approximating a surface (left) by portions of cones (right).

So we need to be able to compute the area of a frustum of a cone. Since the frustum can be formed by removing a small cone from the top of a larger one, we can compute the desired area if we know the surface area of a cone. Suppose a right circular cone has base radius  $r$  and slant height  $h$ . If we cut the cone from the vertex to the base circle and flatten it out, we obtain a sector of a circle with radius  $h$  and arc length  $2\pi r$ , as in figure 9.10.2. The angle at the center, in radians, is then  $2\pi r/h$ , and the area of the cone is equal to the area of the sector of the circle. Let  $A$  be the area of the sector; since the area of the entire circle is  $\pi h^2$ , we have

$$\frac{A}{\pi h^2} = \frac{2\pi r/h}{2\pi}$$

$$A = \pi r h.$$

Now suppose we have a frustum of a cone with slant height  $h$  and radii  $r_0$  and  $r_1$ , as in figure 9.10.3. The area of the entire cone is  $\pi r_1(h_0 + h)$ , and the area of the small cone is  $\pi r_0 h_0$ ; thus, the area of the frustum is  $\pi r_1(h_0 + h) - \pi r_0 h_0 = \pi((r_1 - r_0)h_0 + r_1 h)$ . By

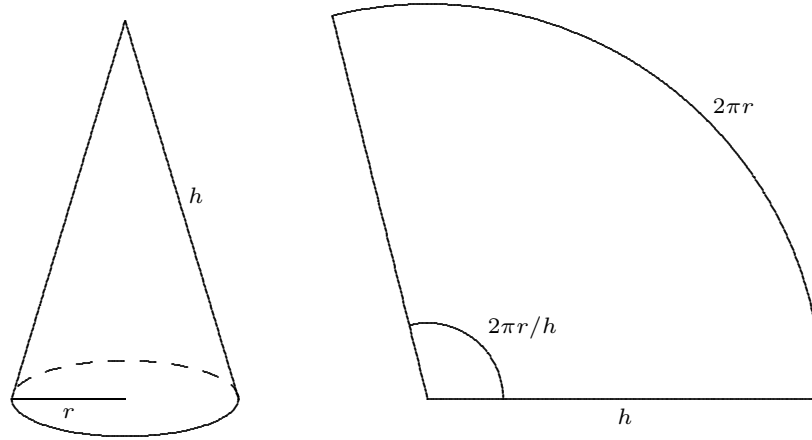

**Figure 9.10.2** The area of a cone.

similar triangles,

$$\frac{h_0}{r_0} = \frac{h_0 + h}{r_1}.$$

With a bit of algebra this becomes  $(r_1 - r_0)h_0 = r_0h$ ; substitution into the area gives

$$\pi((r_1 - r_0)h_0 + r_1h) = \pi(r_0h + r_1h) = \pi h(r_0 + r_1) = 2\pi \frac{r_0 + r_1}{2}h = 2\pi rh.$$

The final form is particularly easy to remember, with  $r$  equal to the average of  $r_0$  and  $r_1$ , as it is also the formula for the area of a cylinder. (Think of a cylinder of radius  $r$  and height  $h$  as the frustum of a cone of infinite height.)

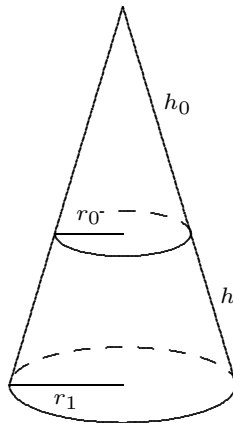

**Figure 9.10.3** The area of a frustum.

Now we are ready to approximate the area of a surface of revolution. On one subinterval, the situation is as shown in figure 9.10.4. When the line joining two points on the

curve is rotated around the  $x$ -axis, it forms a frustum of a cone. The area is

$$2\pi rh = 2\pi \frac{f(x_i) + f(x_{i+1})}{2} \sqrt{1 + (f'(t_i))^2} \Delta x.$$

Here  $\sqrt{1 + (f'(t_i))^2} \Delta x$  is the length of the line segment, as we found in the previous section. Assuming  $f$  is a continuous function, there must be some  $x_i^*$  in  $[x_i, x_{i+1}]$  such that  $(f(x_i) + f(x_{i+1}))/2 = f(x_i^*)$ , so the approximation for the surface area is

$$\sum_{i=0}^{n-1} 2\pi f(x_i^*) \sqrt{1 + (f'(t_i))^2} \Delta x.$$

This is not quite the sort of sum we have seen before, as it contains two different values in the interval  $[x_i, x_{i+1}]$ , namely  $x_i^*$  and  $t_i$ . Nevertheless, using more advanced techniques than we have available here, it turns out that

$$\lim_{n \rightarrow \infty} \sum_{i=0}^{n-1} 2\pi f(x_i^*) \sqrt{1 + (f'(t_i))^2} \Delta x = \int_a^b 2\pi f(x) \sqrt{1 + (f'(x))^2} dx$$

is the surface area we seek. (Roughly speaking, this is because while  $x_i^*$  and  $t_i$  are distinct values in  $[x_i, x_{i+1}]$ , they get closer and closer to each other as the length of the interval shrinks.)

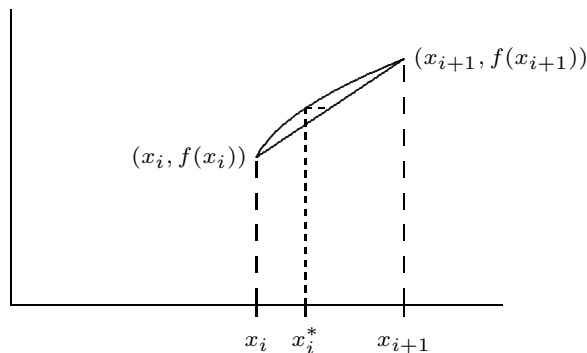

Figure 9.10.4 One subinterval.

**EXAMPLE 9.10.1** We compute the surface area of a sphere of radius  $r$ . The sphere can be obtained by rotating the graph of  $f(x) = \sqrt{r^2 - x^2}$  about the  $x$ -axis. The derivative

$f'$  is  $-x/\sqrt{r^2 - x^2}$ , so the surface area is given by

$$\begin{aligned} A &= 2\pi \int_{-r}^r \sqrt{r^2 - x^2} \sqrt{1 + \frac{x^2}{r^2 - x^2}} dx \\ &= 2\pi \int_{-r}^r \sqrt{r^2 - x^2} \sqrt{\frac{r^2}{r^2 - x^2}} dx \\ &= 2\pi \int_{-r}^r r dx = 2\pi r \int_{-r}^r 1 dx = 4\pi r^2 \end{aligned}$$

□

If the curve is rotated around the  $y$  axis, the formula is nearly identical, because the length of the line segment we use to approximate a portion of the curve doesn't change. Instead of the radius  $f(x_i^*)$ , we use the new radius  $\bar{x}_i = (x_i + x_{i+1})/2$ , and the surface area integral becomes

$$\int_a^b 2\pi x \sqrt{1 + (f'(x))^2} dx.$$

**EXAMPLE 9.10.2** Compute the area of the surface formed when  $f(x) = x^2$  between 0 and 2 is rotated around the  $y$ -axis.

We compute  $f'(x) = 2x$ , and then

$$2\pi \int_0^2 x \sqrt{1 + 4x^2} dx = \frac{\pi}{6} (17^{3/2} - 1),$$

by a simple substitution. □

### Exercises 9.10.

1. Compute the area of the surface formed when  $f(x) = 2\sqrt{1-x}$  between  $-1$  and  $0$  is rotated around the  $x$ -axis.  $\Rightarrow$
2. Compute the surface area of example 9.10.2 by rotating  $f(x) = \sqrt{x}$  around the  $x$ -axis.
3. Compute the area of the surface formed when  $f(x) = x^3$  between  $1$  and  $3$  is rotated around the  $x$ -axis.  $\Rightarrow$
4. Compute the area of the surface formed when  $f(x) = 2 + \cosh(x)$  between  $0$  and  $1$  is rotated around the  $x$ -axis.  $\Rightarrow$
5. Consider the surface obtained by rotating the graph of  $f(x) = 1/x$ ,  $x \geq 1$ , around the  $x$ -axis. This surface is called **Gabriel's horn** or **Toricelli's trumpet**. In exercise 13 in section 9.7 we saw that Gabriel's horn has finite volume. Show that Gabriel's horn has infinite surface area.
6. Consider the circle  $(x-2)^2 + y^2 = 1$ . Sketch the surface obtained by rotating this circle about the  $y$ -axis. (The surface is called a **torus**.) What is the surface area?  $\Rightarrow$



7. Consider the ellipse with equation  $x^2/4 + y^2 = 1$ . If the ellipse is rotated around the  $x$ -axis it forms an **ellipsoid**. Compute the surface area.  $\Rightarrow$
8. Generalize the preceding result: rotate the ellipse given by  $x^2/a^2 + y^2/b^2 = 1$  about the  $x$ -axis and find the surface area of the resulting ellipsoid. You should consider two cases, when  $a > b$  and when  $a < b$ . Compare to the area of a sphere.  $\Rightarrow$

